

IGBT Modules

V_{CES}	1200V
I_C	10A

Applications

- Motor Drivers
- AC and DC servo drive amplifier
- UPS (Uninterruptible Power Supplies)

Features

- Low switching losses
- Low v_{ce(sat)} with positive temperature coefficient
- Including fast & soft recovery anti-parallel FWD
- Low inductance case
- High short circuit capability(10us)
- Isolated heatsink using DBC technology
- Maximum junction temperature 175

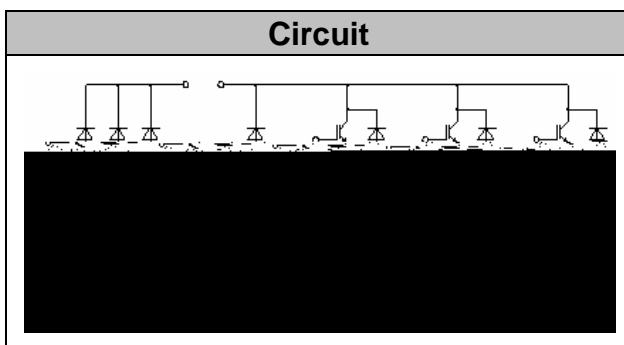

IGBT- inverter

Absolute Maximum Ratings

Parameter	Symbol	Conditions	Value	Unit
Collector-Emitter Voltage	V _{CES}	V _{GE} =0V, I _C =1mA, T _{vj} =25	1200	V
Continuous Collector Current	I _C	T _c =100 ,T _{vjmax} =175	10	A
Repetitive Peak Collector Current	I _{CRM}	tp=1ms	20	A
Gate-Emitter Voltage	V _{GES}	T _{vj} =25	±20	V
Total Power Dissipation	P _{tot}	T _c =25 T _{vjmax} =175	140	W



MG10P12P2

RoHS
COMPLIANT

IGBT- inverter Characteristic values

Parameter	Value					
Gate-emitter Threshold Voltage	$V_{GE(th)}$	$V_{GE}=V_{CE}, I_C=0.5mA, T_{vj}=25$	5.2	6.0	6.6	V
Collector-Emitter Cut-off Current	I_{CES}	$V_{CE}=1200V, V_{GE}=0V, T_{vj}=25$			1.0	mA
Collector-Emitter Saturation Voltage		$I_C=10A, V_{GE}=15V, T_{vj}=25$		1.85	2.20	
		$I_C=10A, V_{GE}=15V, T_{vj}=150$		2.25		

Input Capacitance

C_{ies}

$V_{CE}=0V, V_{GE}=20V, T_{vj}=25$			400	nA
		85		ns
$I_C=10A$		50		ns

~~$T_{vj}=25$~~
~~Power Dissipation During IGBT Turn-off~~ ~~0.00~~ ~~mJ~~ ~~CE~~ ~~erg~~ ~~Å~~ ~~B~~



Diode-inverter Absolute Maximum Ratings

Parameter	Symbol	Conditions	Value	Unit
Repetitive Peak Reverse Voltage	V_{RRM}	$T_{vj}=25$	1200	V
Continuous DC Forward Current	I_F		10	A
Repetitive Peak Forward Current	I_{FRM}	$t_p=1ms$	20	A
I^2t -value	I^2t	$V_R=0, t_p=10ms, T_{vj}=125$	16.0	A^2s
		$V_R=0, t_p=10ms, T_{vj}=150$	14.0	

Characteristic values

Parameter	Symbol	Conditions	Value			Unit
			Min.	Typ.	Max.	
Forward Voltage	V_F	$I_F=10A, T_{vj}=25$		2.0	2.5	V
		$I_F=10A, T_{vj}=125$		2.1		
		$I_F=10A, T_{vj}=150$		2.1		
Recovered Charge	Q_{rr}	$I_F=10A$		0.90		μC
Peak Reverse Recovery Current	I_{rr}	$V_R=600V$ $-di_F/dt=500A/\mu s$		12.5		A
Reverse Recovery Energy	E_{rec}	$T_{vj}=25$		0.25		mJ
Recovered Charge	Q_{rr}	$I_F=10A$		1.70		μC
Peak Reverse Recovery Current	I_{rr}	$V_R=600V$ $-di_F/dt=500A/\mu s$		10.4		A
Reverse Recovery Energy	E_{rec}	$T_{vj}=125$		0.50		mJ



IGBT-brake-chopper Absolute Maximum Ratings

Parameter	Symbol	Conditions	Value	Unit
Collector-Emitter Voltage	V_{CES}	$V_{GE}=0V, I_C=1mA, T_{vj}=25$	1200	V
Continuous Collector Current	I_C	$T_c=100, T_{vjmax}=175$	10	A
Repetitive Peak Collector Current	I_{CRM}	$t_p=1ms$	20	A
Gate-Emitter Voltage	V_{GES}	$T_{vj}=25$	± 20	V
Total Power Dissipation	P_{tot}	$T_c=25, T_{vjmax}=175$	105	W

Characteristic values

o s m b l

Condit



Turn-on Delay Time	$t_{d(on)}$	$I_C = 10A$ $V_{CE} = 600V$ $V_{GE} = \pm 15V$ $R_G = 47$ $T_{vj} = 125$		90		ns
Rise Time	t_r			60		ns
Turn-off Delay Time	$t_{d(off)}$			285		ns
Fall Time	t_f			150		ns
Energy Dissipation During Turn-on Time	E_{on}			1.33		mJ
Energy Dissipation During Turn-off Time	E_{off}			0.9		mJ
SC Data	I_{sc}	$T_p = 10\mu s, V_{GE} = 15V, T_{vj} = 150$, $V_{cc} = 900V, V_{CEM} = 1200V$		70		A

Diode-Brake-Chopper

Absolute Maximum Ratings

Parameter	Symbol	Conditions	Value	Unit
Repetitive Peak Reverse Voltage	V_{RRM}	$T_j = 25$	1200	V
Continuous DC Forward Current	I_F		10	A
Repetitive Peak Forward Current	I_{FRM}	$t_p = 1ms$	20	A
I^2t -value	I^2t	$V_R = 0, t_p = 10ms, T_j = 125$	16.0	A ² s
		$V_R = 0, t_p = 10ms, T_j = 150$	14.0	

Characteristic values

Parameter	Symbol	Conditions	Value			Unit
			Min.	Typ.	Max.	
Forward Voltage	V_F	$I_F = 10A, T_{vj} = 25$		2.0	2.5	V
		$I_F = 10A, T_{vj} = 125$		2.1		
		$I_F = 10A, T_{vj} = 150$		2.1		
Recovered Charge	Q_{rr}	$I_F = 10A$		0.90		μC
Peak Reverse Recovery Current	I_{rr}	$V_R = 600V$ $-di_F/dt = 500A/\mu s$		12.5		A
Reverse Recovery Energy	E_{rec}	$T_{vj} = 25$		0.25		mJ
Recovered Charge	Q_{rr}	$I_F = 10A$		1.70		μC
Peak Reverse Recovery Current	I_{rr}	$V_R = 600V$ $-di_F/dt = 500A/\mu s$		10.4		A
Reverse Recovery Energy	E_{rec}	$T_{vj} = 125$		0.50		mJ



Diode-Rectifier Absolute Maximum Ratings

Parameter	Symbol	Conditions	Value	Unit
Repetitive Peak Reverse Voltage	V_{RRM}	$T_j=25$	1600	V
Average output Current 50/60Hz, sine wave	$I_{F(AV)}$	$T_c=100$	10	A
Maximum RMS Current at Rectifier Output	I_{RMSM}	$T_c=100$	10	A
Surge Forward Current	I_{FSM}	$V_R=0, t_p=10ms, T_j=45$	150	A
I^2t -value	I^2t	$V_R=0, t_p=10ms, T_j=45$	110	A ² s

Characteristic values

Parameter	Symbol	Conditions	Value			Unit
			Min.	Typ.	Max.	
Diode Forward Voltage	V_F	$I_F=10A, T_j=150$		1.00		V
Reverse Current	I_R	$T_j=150, V_R=1600V$			1.0	mA

NTC-Thermistor Characteristic values

Parameter	Symbol	Conditions	Value			Unit
			Min.	Typ.	Max.	
Rated Resistance	R_{25}			5.0		k
Deviation of R100	R/R	$T_c=100, R_{100}=493.3$	-5		5	%
Power Dissipation	P_{25}				20.0	mW
B-value	$B_{25/50}$	$R_2=R_{25}\exp[B_{25/50}(1/T_2-1/(298.15K))]$		3375		K

۳۱

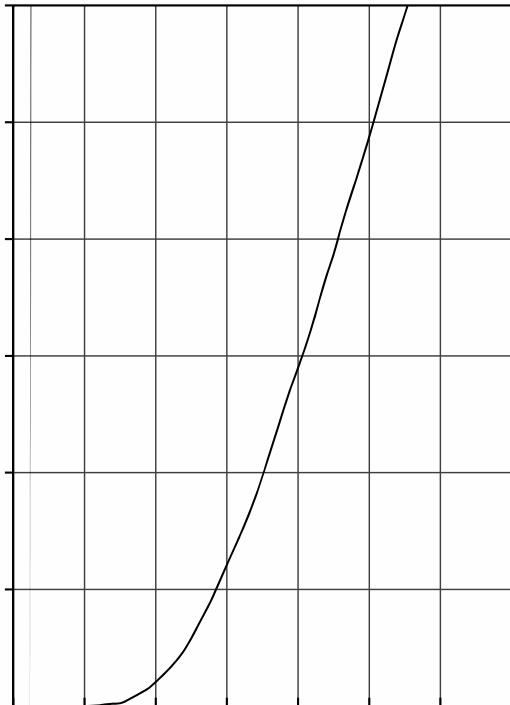
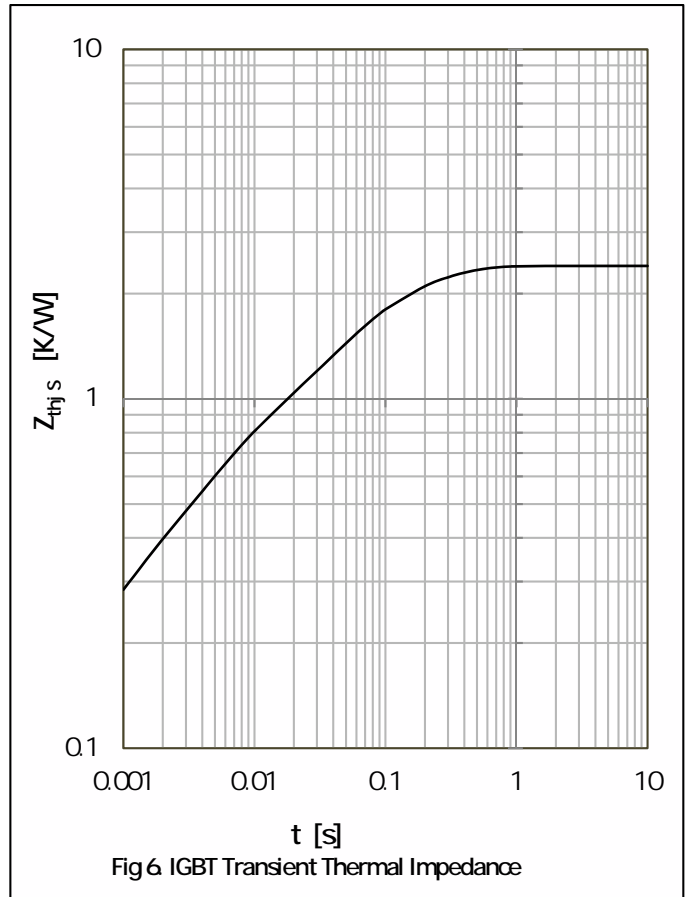
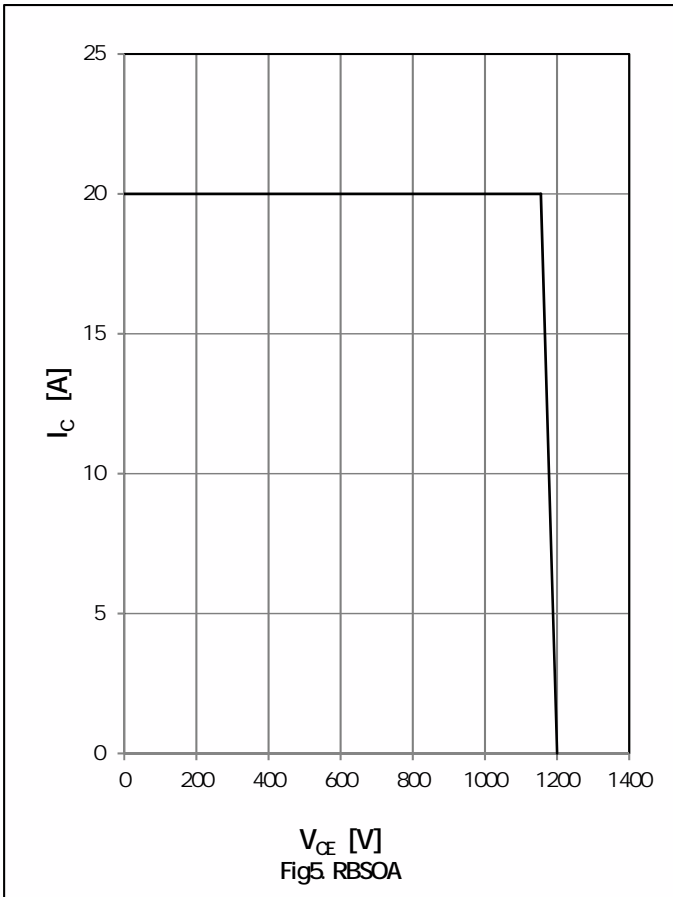

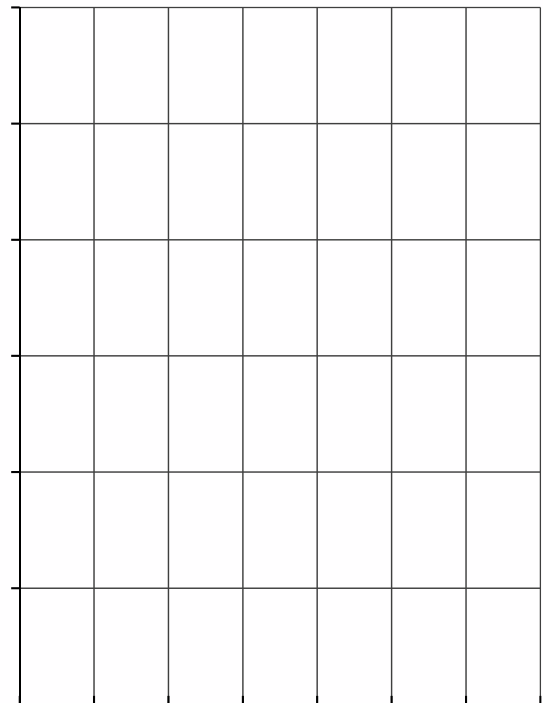
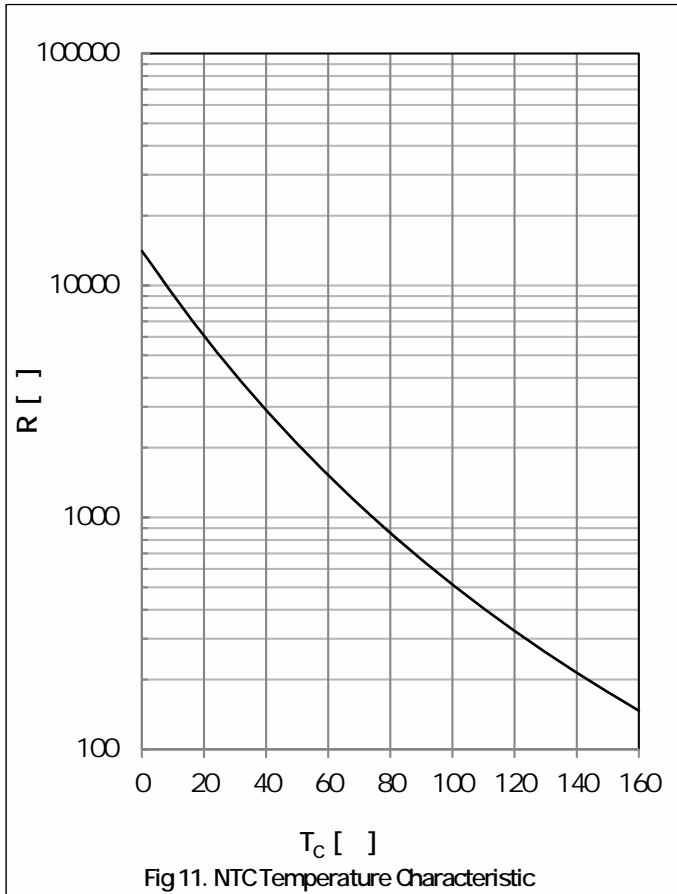
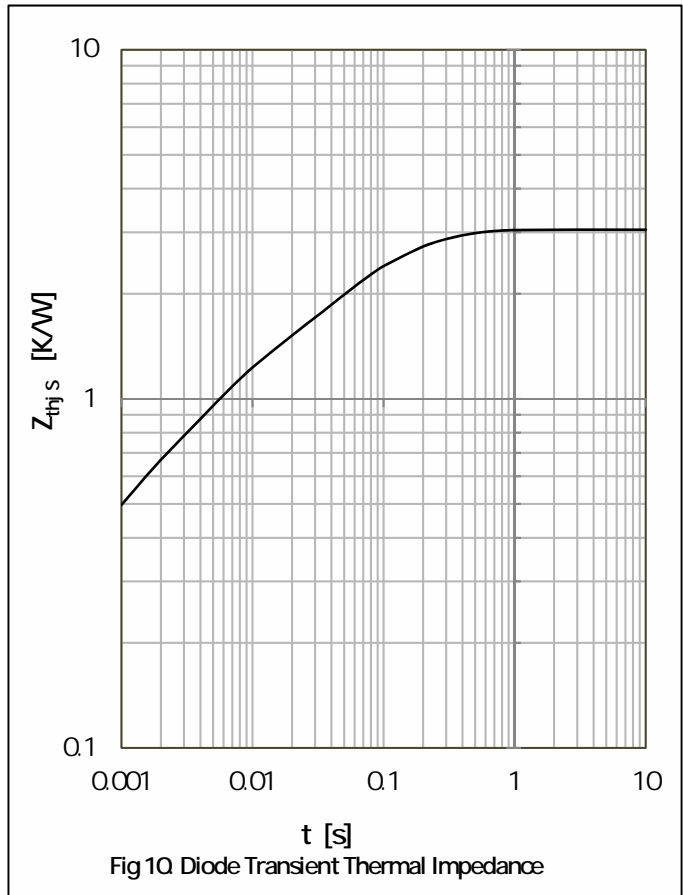
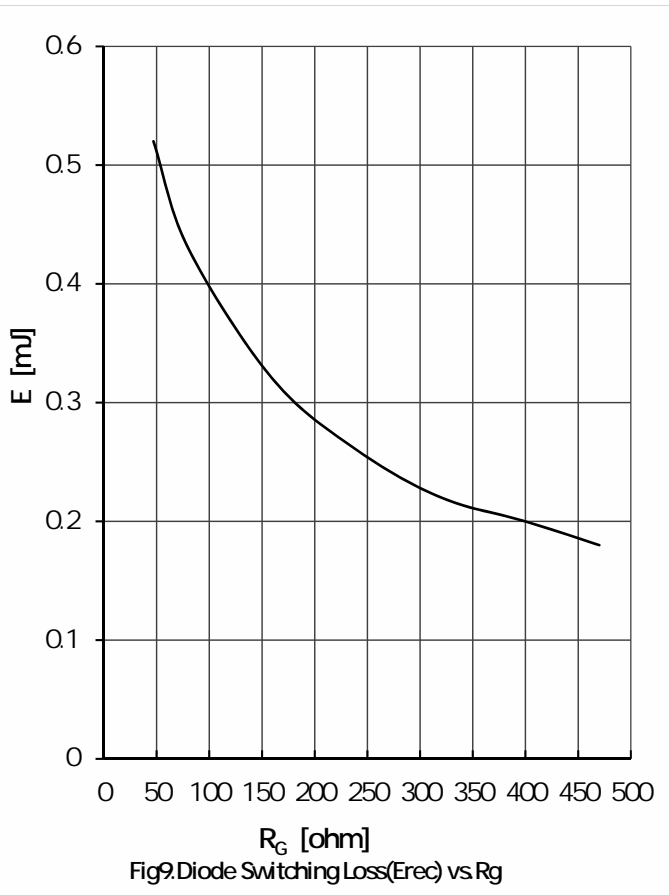

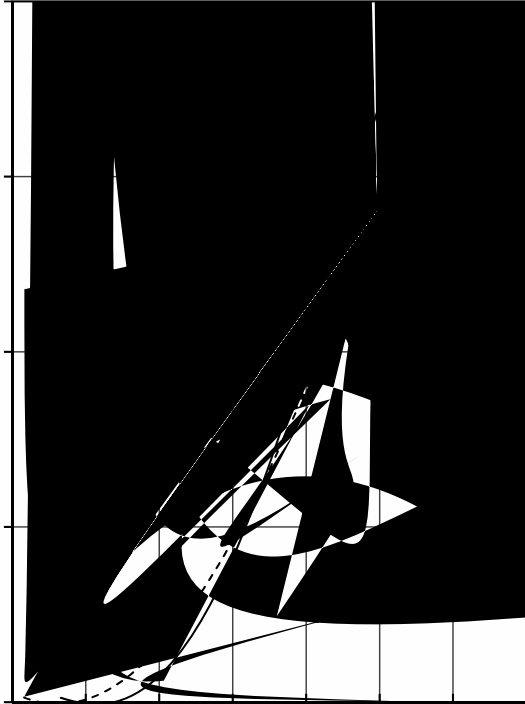



Circuit Diagram

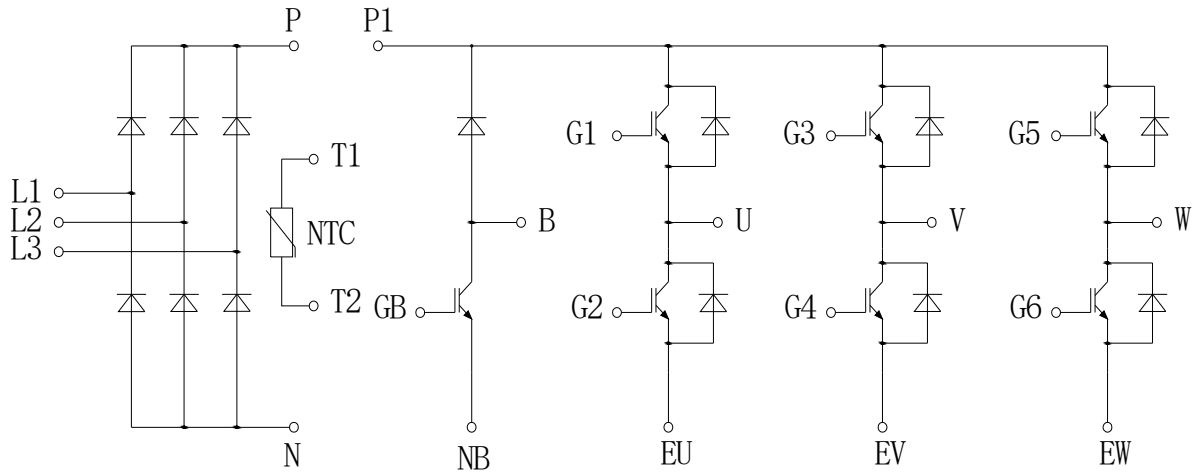

Package Dimensions

