

一级代理商：

深圳市弗瑞鑫电子有限公司

地址：深圳市宝安区西乡大道302号金源商务大厦B座三楼

frxelec

1. Features



2. Instructions

3. Application Range

4. Functional Diagram

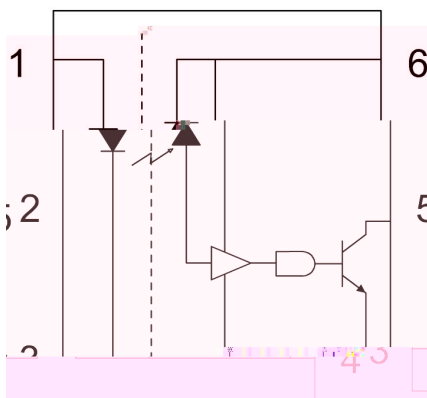

5. Absolute Maximum Ratings (Ta=25°C)*1

Parameter		Symbol	Rated Value	Unit

6. Recommended Operating Conditions

Parameter	Symbol	Min	Max	Unit

7. Opto-Electronic Characteristics

	Parameter	Symbol	Min	Typ	Max	Unit	Condition
Input							
Detector							

	Parameter	Symbol	Min	Typ	Max	Unit	Condition
Input							
Detector							

8. Switching Characteristics

Parameter	Symbol	Min	Typ	Max	Unit	Condition
-----------	--------	-----	-----	-----	------	-----------

9. Order Information

Part Number

OR-M6XX-W-Y-Z

Note

Option	Description	Packing quantity

10. Naming Rule

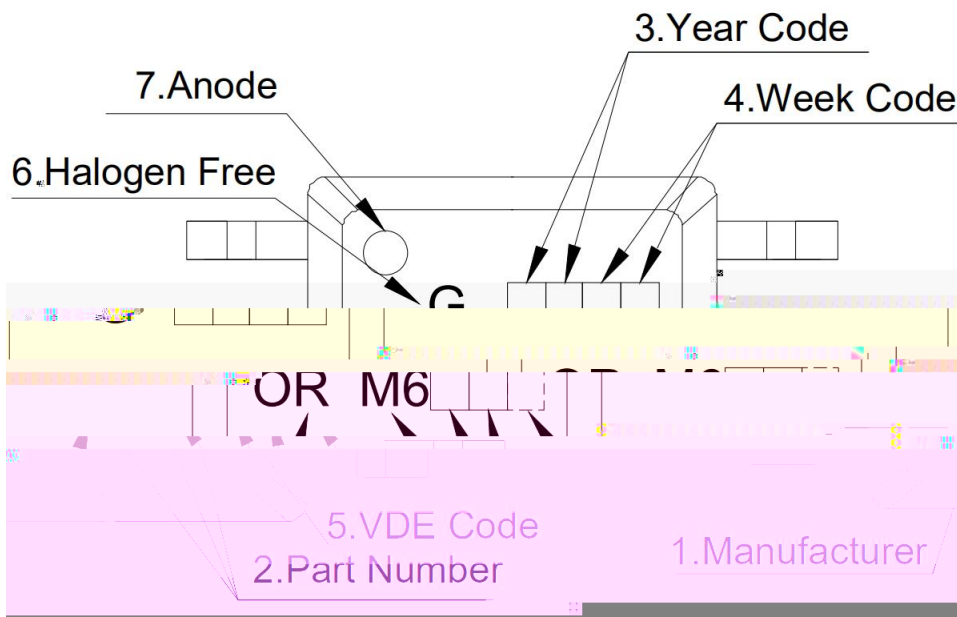

□□ :

□□ :

□□

11. Outer Dimension

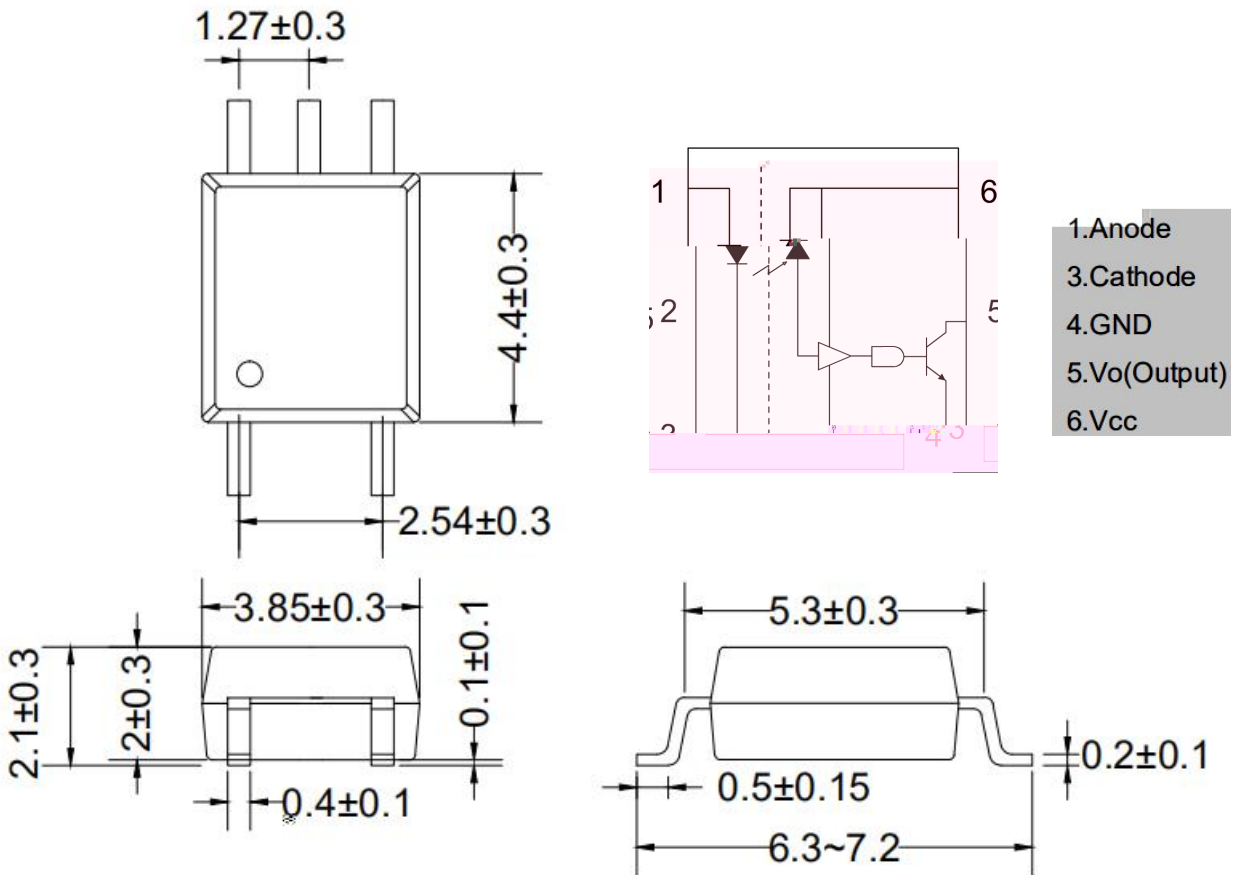

12. Recommended Foot Print Patterns (Mount Pad)

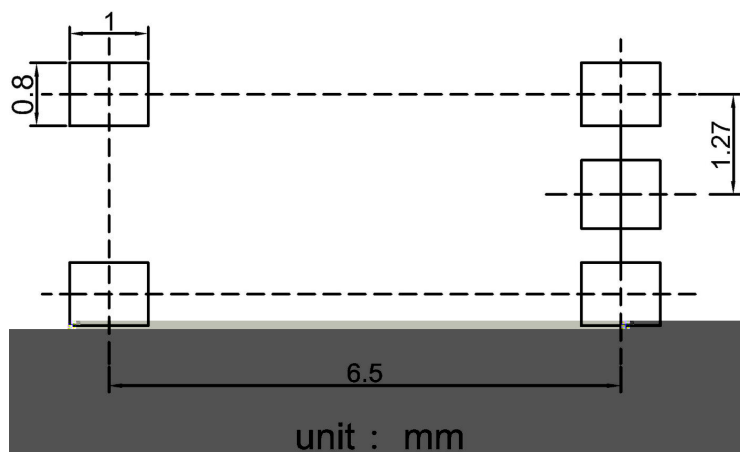



14. Package Dimension

Packing Information	



ORIENT
ShenZhen Orient
Components Co.,LTD

Material Code : 120PCXXXXXX..

|||||

P/N: OR-XXXXXX

|||||

Lot No.: XXXXXX-XXXX-TX-X

|||||

D/C: XXXX

|||||

Qty: XXXX PCS

|||||

内箱码

外箱码

“XXXXXXXXXXXXXXXX” (一体机序列码)

Made in China

Note:

15. Reliability Test

NO.	ITEMS	QTY. (Pcs)	Condition	Process	Device	Standard
	RSH 焊接热			次	炉	
	HTSL 温存储				温烤 测 仪	
	LTSL 低温存储				低温 测 仪	
	TC 温度循				冷热冲 击机	
	TS 温度冲击				冷热冲 击机	
	HTOL 温操作				温烤 测 仪、 化板	
	ESD-HB M 人体模式			次	测 仪	
	SD 可焊性			次	炉	
	温湿寿命				恒温恒湿 机, 测 仪	
	Autoclave 压力				压力	

16. Temperature Profile Of Soldering

Profile item	Conditions

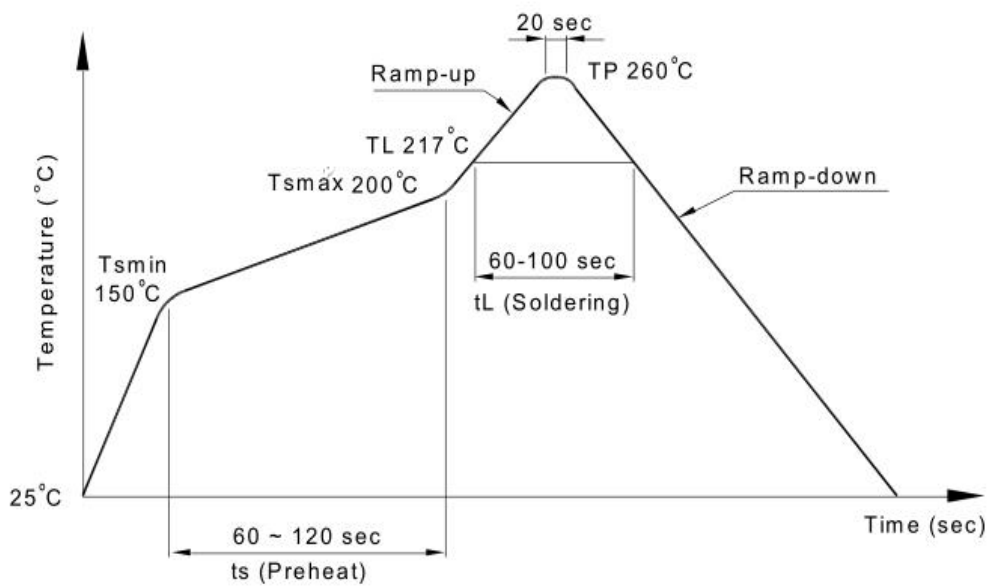

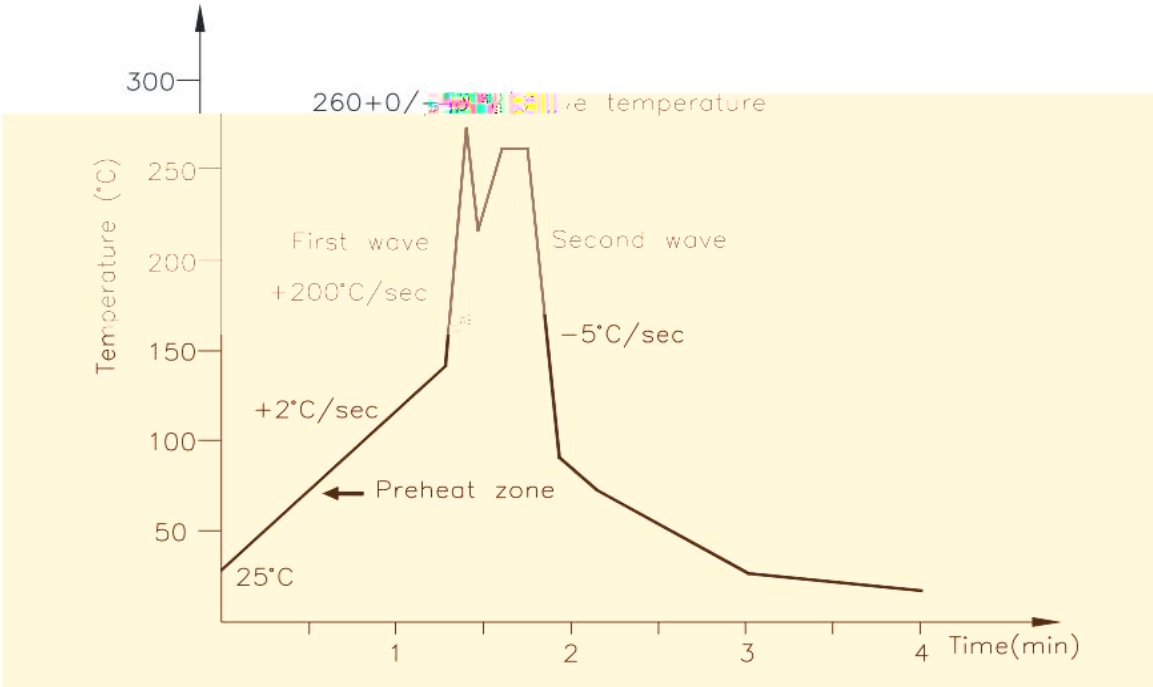

--	--



17. Switching time test circuit

18. Characteristics Curve

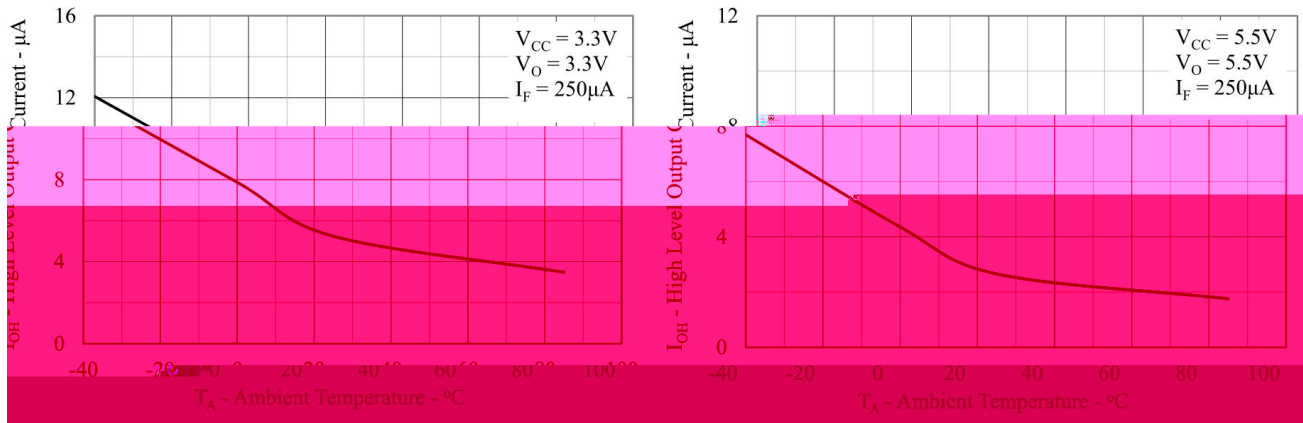

Figure 3: Typical high level output current vs. temperature.

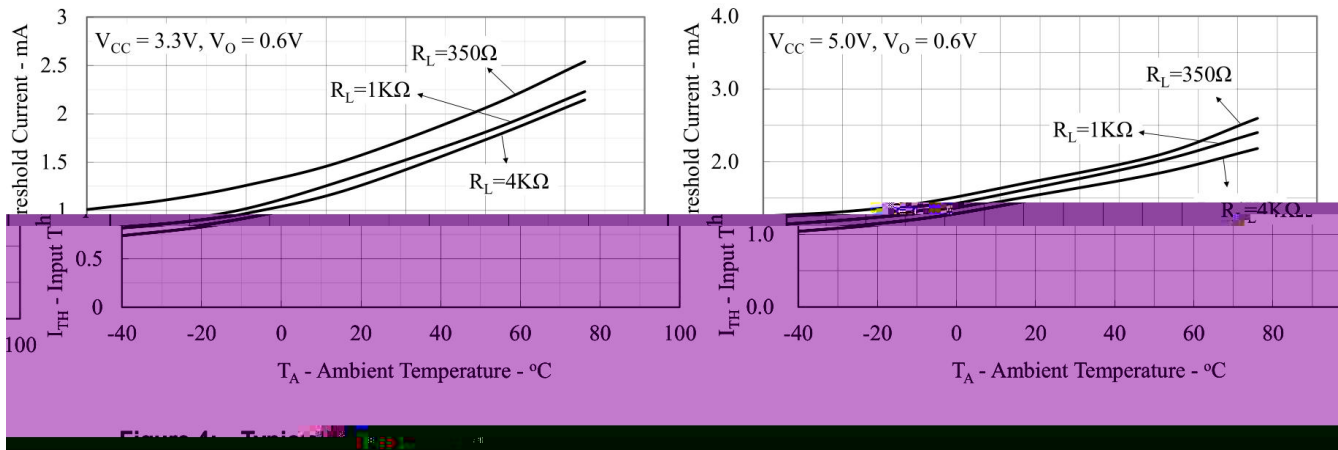

Figure 4: Typical threshold current vs. temperature.

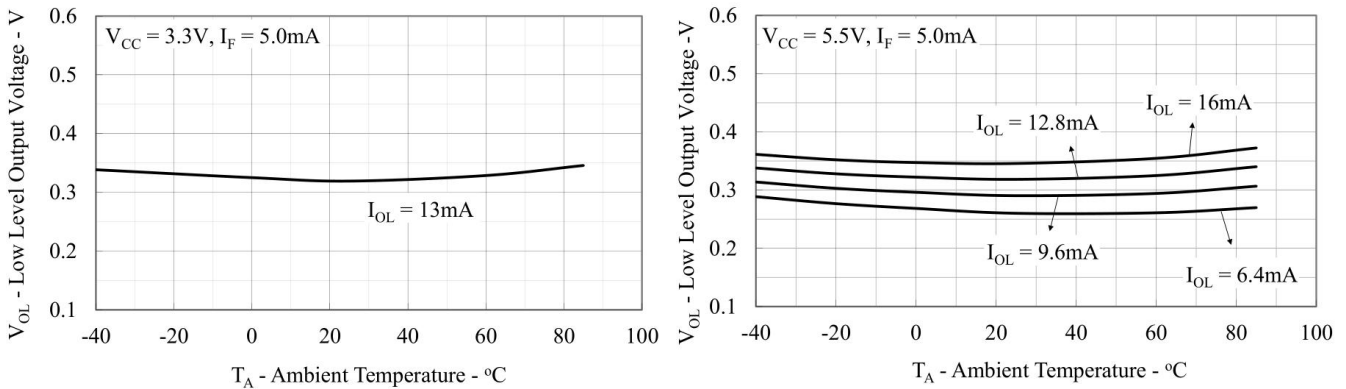

Figure 5: Typical Low Level Output Voltage vs. Ambient Temperature

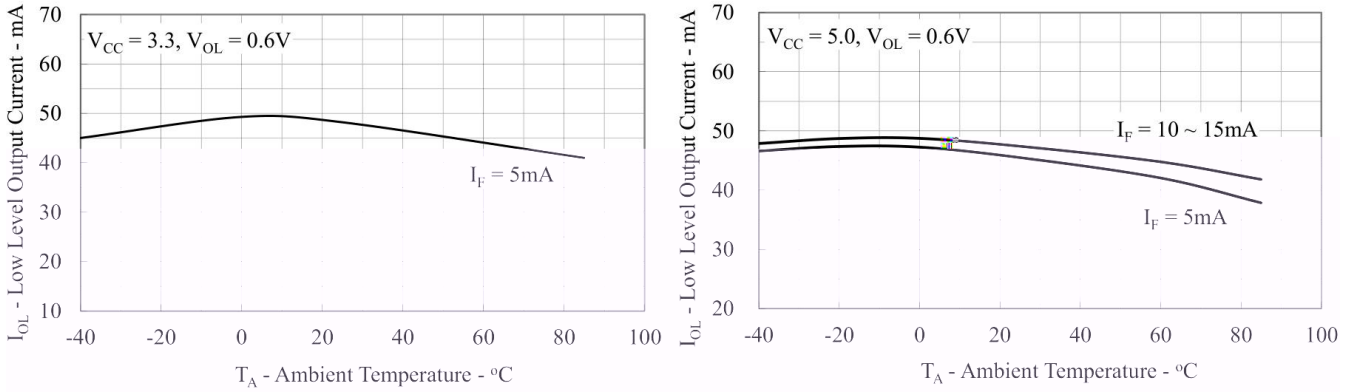

Figure 6: Typical Low Level Output Current vs. Ambient Temperature

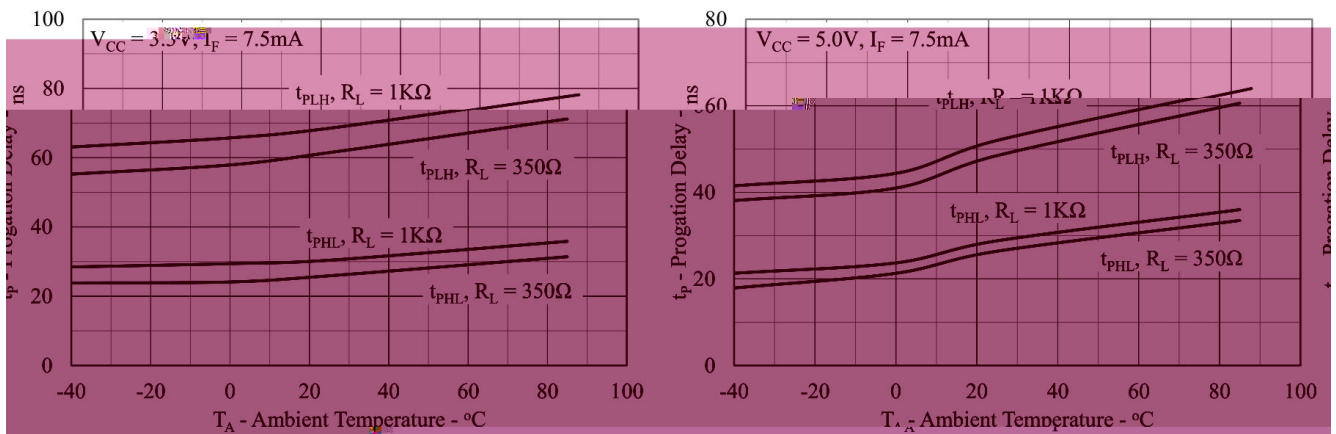

Figure 8: Typical Propagation Delay vs. Ambient Temperature

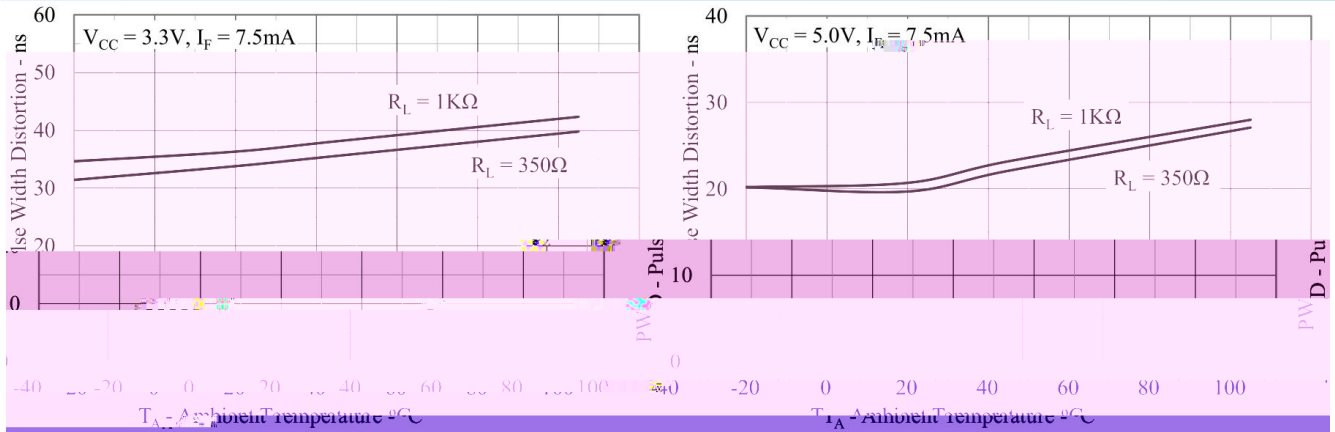

Figure 10: Typical Pulse Width Distortion vs. Ambient

