

## Glass Passivated Three Phase Rectifier Bridge

**VRRM** 800 to 1800V  
**ID** 250 A

### Applications

- Three phase rectifiers for power supplies
- Rectifiers for DC motor field supplies
- Battery charger rectifiers
- Input rectifiers for variable frequency drives

### Features

- Three phase bridge rectifier
- Blocking voltage:800 to 1800V
- Heat transfer through aluminum oxide DBC ceramic isolated metal baseplate
- Glass passivated chip
- UL recognized applied for file no. E360040

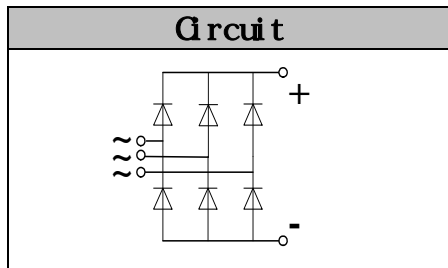

### Module Type

TYPE	VRRM	VRSM
MD250S08M3	800V	900V
MD250S12M3	1200V	1300V
MD250S16M3	1600V	1700V
MD250S18M3	1800V	1900V

### Maximum Ratings

Symbol	Conditions	Values	Units
ID	Three phase, full wave Tc=100	250	A
IFSM	t=10mS Tvj =45	2500	A
i <sup>2</sup> t	t=10mS Tvj =45	31250	A <sup>2</sup> s
Visol	a.c.50HZ;r.m.s.;1min	3000	V
Tvj		-40 to +150	
Tstg		-40 to +125	
Mt	To terminals (M6)	5±15%	Nm
Ms	To heatsink (M6)	5±15%	Nm
Weight	Module (Approximately)	230	g

### Thermal Characteristics

Symbol	Conditions	Values	Units
Rth(j-c)	Per diode	0.36	/W
Rth(c-s)	Module (Approximately)	0.02	/W

### Electrical Characteristics

Symbol	Conditions	Values			Units
		Min.	Typ.	Max.	
VFM	T=25 IF =300A		1.35	1.6	V
IRD	Tvj=25 VRD=VRRM			0.5	mA
	Tvj=150 VRD=VRRM			6	mA



### Performance Curves

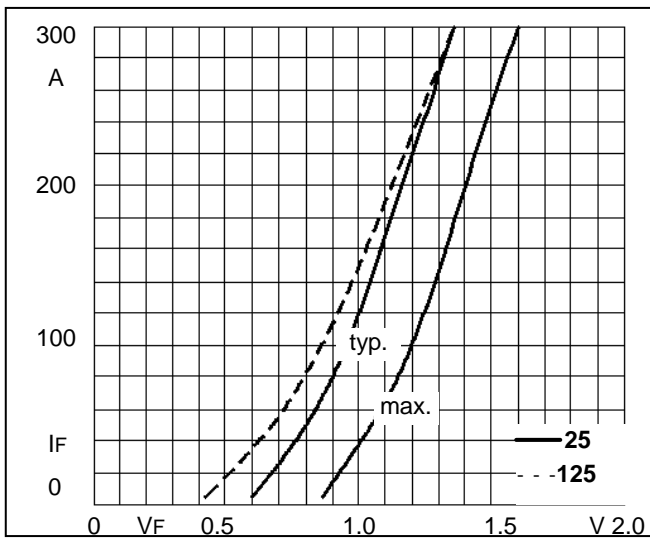

**Fig1. Forward Characteristics**

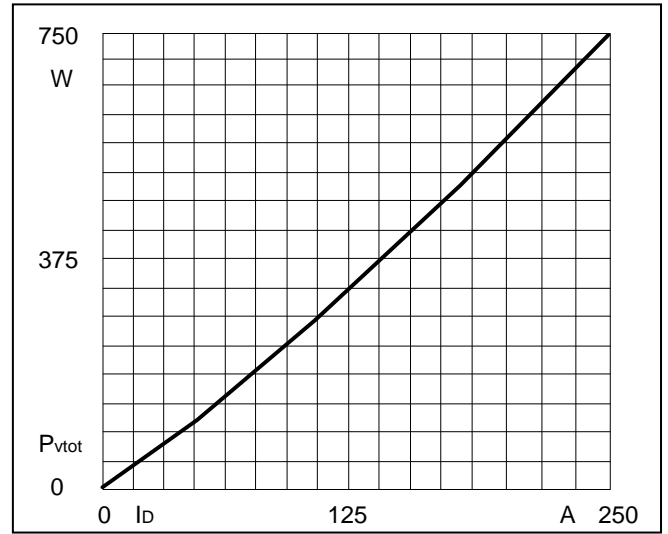

**Fig2. Power dissipation**

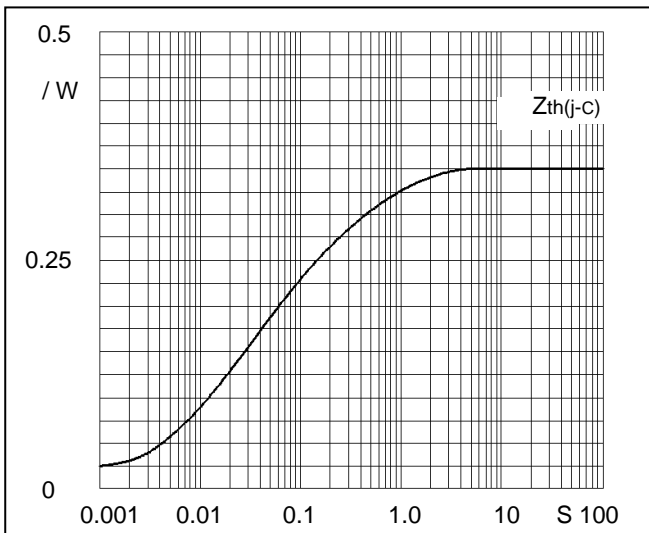

**Fig3. Transient thermal impedance**

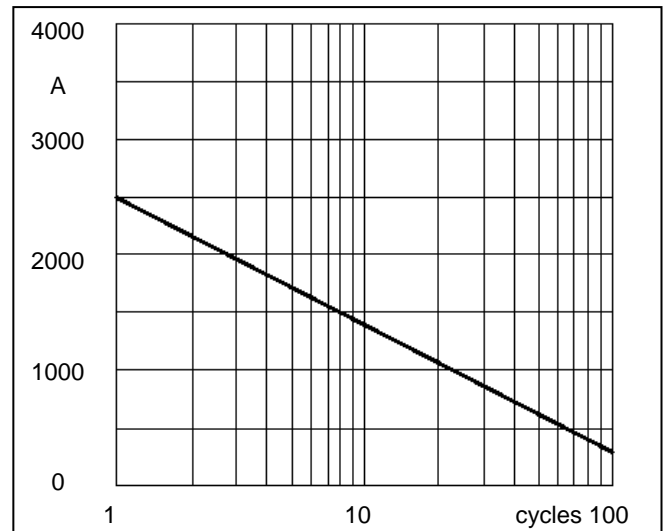

**Fig4. Max Non-Repetitive Forward Surge Current**

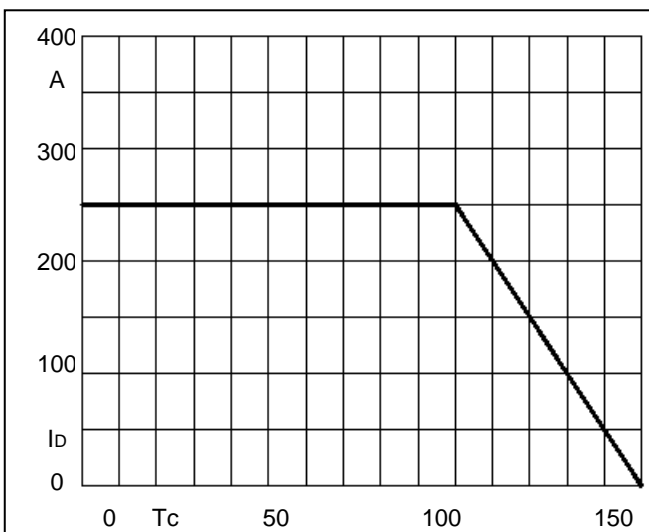

**Fig5. Forward Current Derating Curve**

**Package Outline Information**

**CASE M3**

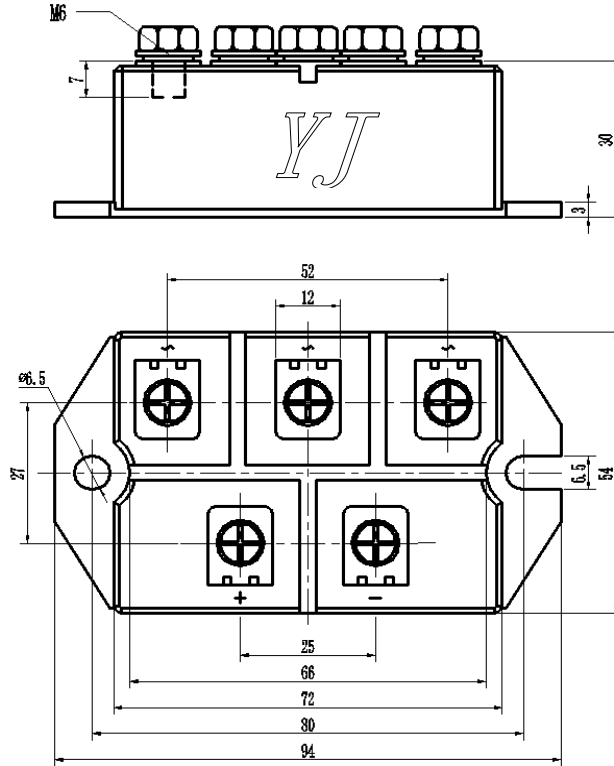

**Dimensions in mm**