

S8550

TRANSISTOR(PNP)

FEATURES

Complimentary to S8050

Collector current: $I_C=0.5A$

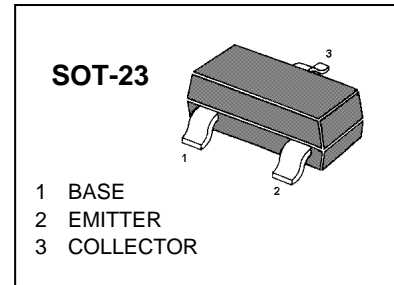

MARKING : 2TY

MAXIMUM RATINGS ($T_A=25^\circ C$ unless otherwise noted)

Symbol	Parameter	Value	Units
V_{CBO}	Collector-Base Voltage	-40	V
V_{CEO}	Collector-Emitter Voltage	-25	V
V_{EBO}	Emitter-Base Voltage	-5	V
I_C	Collector Current -Continuous	-0.5	A
P_C	Collector Power Dissipation	0.3	W
T_j	Junction Temperature	150	$^\circ C$
T_{stg}	Storage Temperature	-55-150	$^\circ C$

ELECTRICAL CHARACTERISTICS ($T_{amb}=25^\circ C$ unless otherwise specified)

Parameter	Symbol	Test conditions	MIN	MAX	UNIT
Collector-base breakdown voltage	$V_{(BR)CBO}$	$I_C = -100\mu A, I_E=0$	-40		V
Collector-emitter breakdown voltage	$V_{(BR)CEO}$	$I_C = -1mA, I_B=0$	-25		V
Emitter-base breakdown voltage	$V_{(BR)EBO}$	$I_E = -100\mu A, I_C=0$	-5		V
Collector cut-off current	I_{CBO}	$V_{CB} = -40V, I_E=0$		-0.1	μA
Collector cut-off current	I_{CEO}	$V_{CE} = -20V, I_B=0$		-0.1	μA
Emitter cut-off current	I_{EBO}	$V_{EB} = -3V, I_C=0$		-0.1	μA
DC current gain	$h_{FE(1)}$	$V_{CE} = -1V, I_C = -50mA$	200	350	
	$h_{FE(2)}$	$V_{CE} = -1V, I_C = -500mA$	50		
Collector-emitter saturation voltage	$V_{CE(sat)}$	$I_C = -500mA, I_B = -50mA$		-0.6	V
Base-emitter saturation voltage	$V_{BE(sat)}$	$I_C = -500mA, I_B = -50mA$		-1.2	V
Transition frequency	f_T	$V_{CE} = -6V, I_C = -20mA$ $f=30MHz$	150		MHz

Typical Characteristics

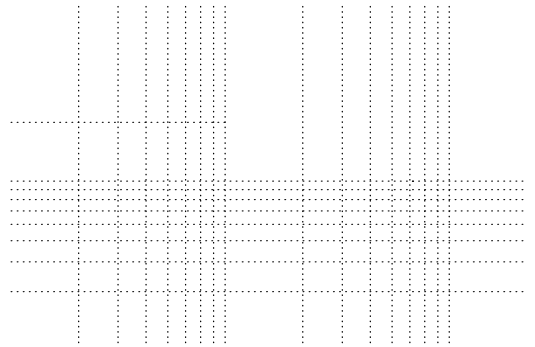
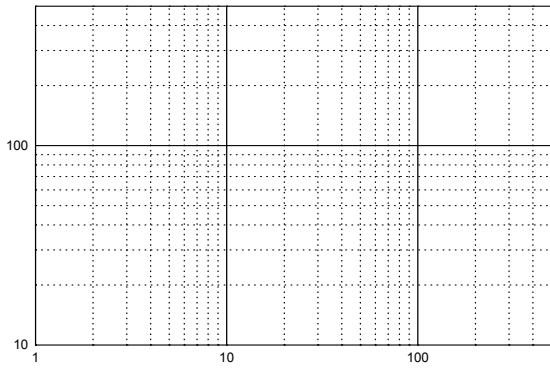
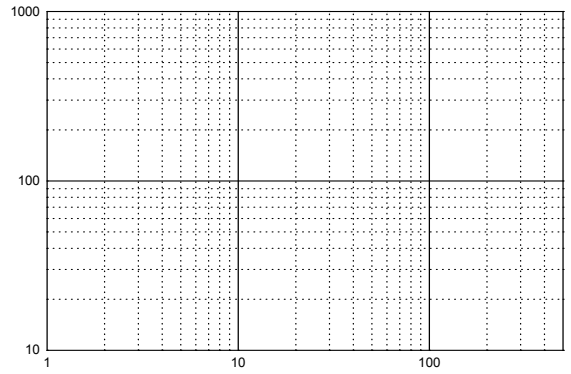

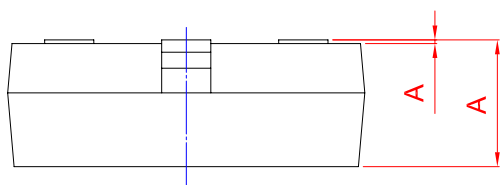
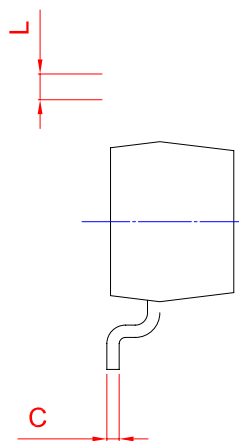
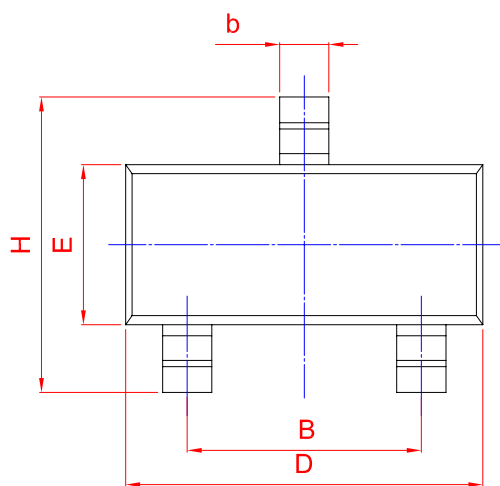
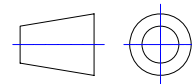

UNIT	A				D	E		A ₁	
mm	1.40 (