

# BAW56

## Features

- Small package
- Low forward voltage
- Fast reverse recovery time
- Small total capacitance

## Applications

- Ultra high speed switching application

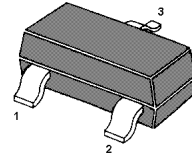
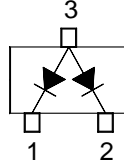

SOT-23 Plastic Package

## Absolute Maximum Ratings ( $T_a = 25\text{ }^\circ\text{C}$ )

Parameter	Symbol	Value	Unit
Peak Repetitive Reverse Voltage	$V_{RRM}$	85	V
Continuous Reverse Voltage	$V_R$	75	V
Forward Current (DC)	$I_F$	215 125	mA
Repetitive Peak Forward Current	$I_{FRM}$	450	mA
Non-PT voltage			



# BAW56

## Silicon Epitaxial Planar Switching Diode

### Typical Characteristics

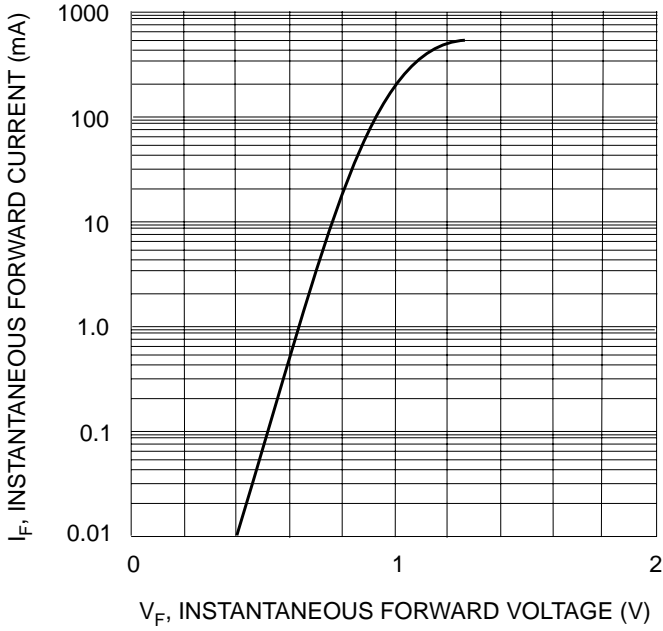

Fig. 1 Forward Characteristics

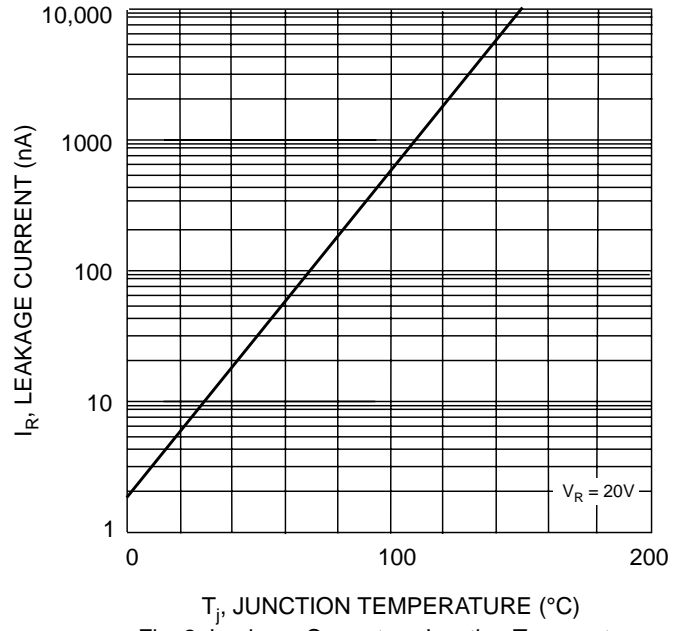

Fig. 2 Leakage Current vs Junction Temperature

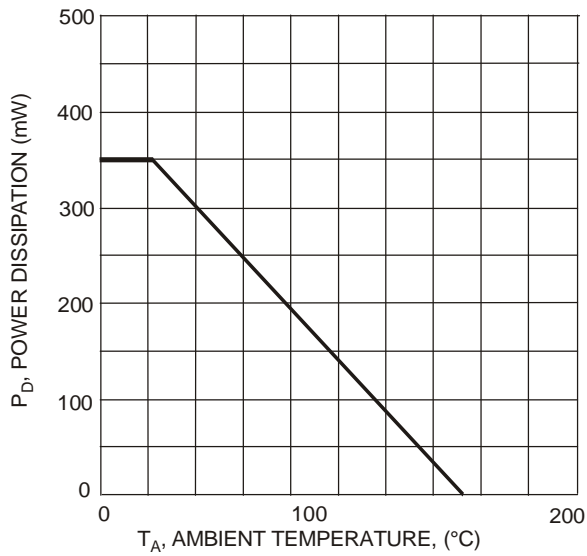
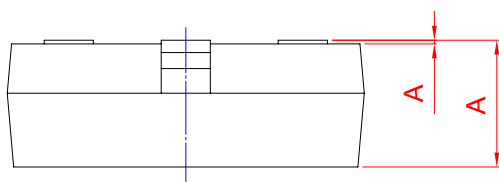
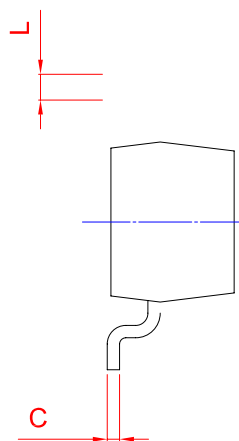
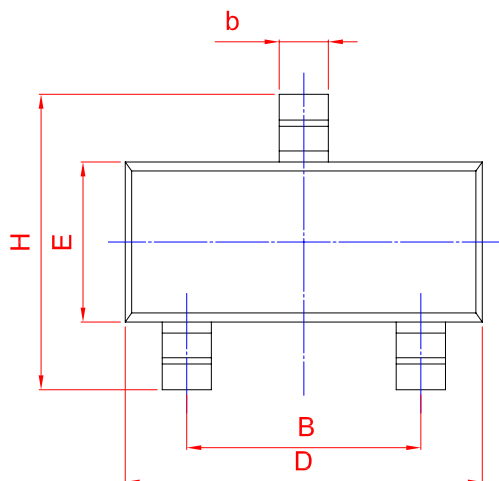
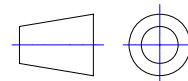

Fig. 3 Power Derating Curve, Total Package



UNIT	A				D	E		A <sub>1</sub>	
mm	1.40		0.50	0.19	3.10				
	0.95		0.35	0.08	2.70				