

深圳市弗瑞鑫电子有限公司

规格承认书

—

prepare	
check	
approve	



TRX电容一级代理商

深圳市弗瑞鑫电子有限公司

Add:深圳市宝安区西乡大道302号金源商务大厦B座3楼

Tel:0755-29563634

Fax:0755-27447020

2

2 . .

/

/

/

/

	2 2 . .		
	/		/
	/		/

 TRX 专注电容器廿年	2 2 . .		
	/		/
	/		/

1. /

$\overline{\text{①}}$ $\overline{\text{②}}$ $\overline{\text{③}}$ $\overline{\text{④}}$ $\overline{\text{⑤}}$ $\overline{\text{⑥}}$

①		
②		
③		
④		
⑤		
⑥		

2. /

	 TRX TL E 102M X1 440V~
--	---

	2 2 . .		
	/		/
	/		/

3. /



4. /

5. /

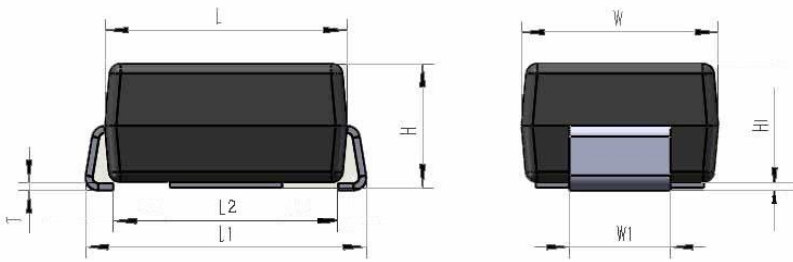



①		
②		
③		
④		
⑤		

2
2 ..

/

/

/

	2 2 . .		
	/		/
	/		/

/

- °
- °C
- °
- °
- °

/

7. /

	2 2 . .		
	/		/
	/		/



 TRX 专注电容器廿年	2		
	2 . .		
	/		/
	/		/

8. /

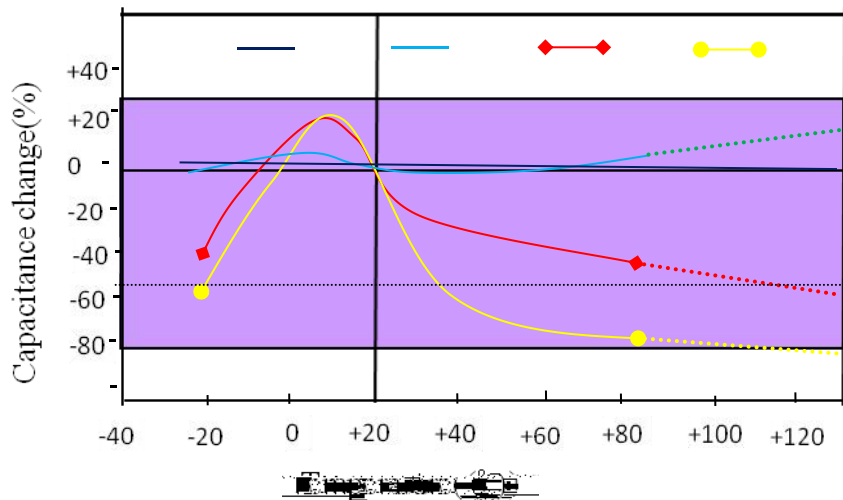

 TRX 专注电容器廿年	2		
	2 ..		
	/		/
	/		/

9. /



10. /

(1)

(2)

/
/

(3)

(4)

11. /
/

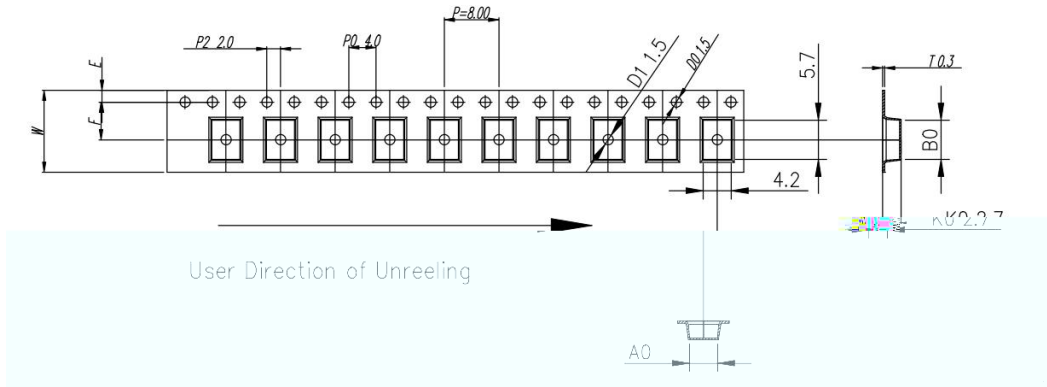

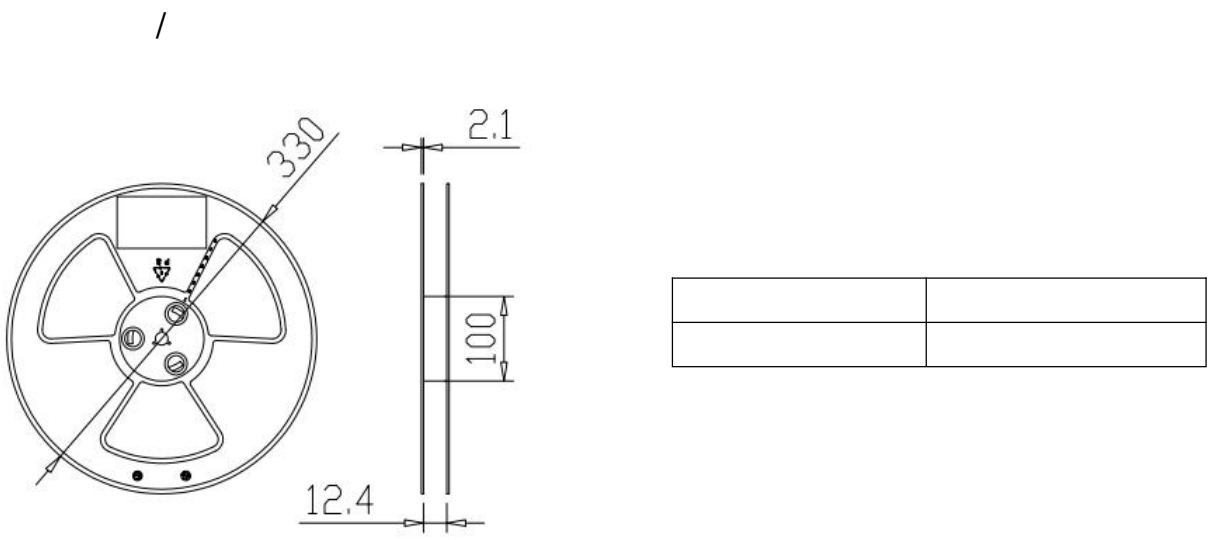

ITEM	W	A0	B0	K1	K0	P	F	E	D0	D1	P0	P2	T
DIM	12.0	$4.38^{+0.30}_{-0.30}$	$5.70^{+0.10}_{-0.10}$	--	$2.70^{+0.10}_{-0.10}$	8.00	$5.50^{+0.10}_{-0.10}$	1.75	$\phi 1.5^{+0.10}_{-0.10}$	$\phi 1.5^{+0.10}_{-0.10}$	4.0	2.0	0.30
ALTERNATE													

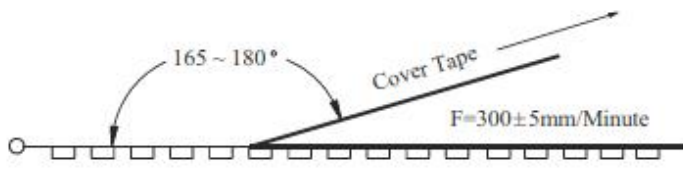

Item	Data	Remark
Cover tape adhesion	10 ~ 100g	Carrier tape and cover tape open angle 165 ~ 180° F=300±5mm/minute

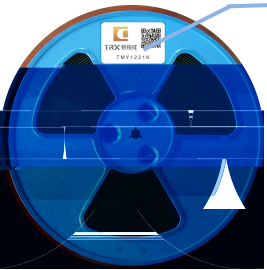

 TRX 专注电容器廿年	2 2 . .			
	/		/	
	/		/	

/ -	 <p>标签</p>		 <p>料号</p>			

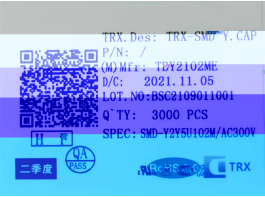

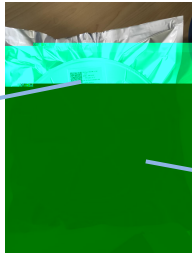

TRX Des: TRX-SMD Y. CAP
 P/N: /
 (M) Mfr: TBY2102ME
 D/C: 2021.11.05
 LOT. NO: BSC2109011001
 QTY: 3000 PCS
 SPEC: SMD-Y2V5U102M/AC300V

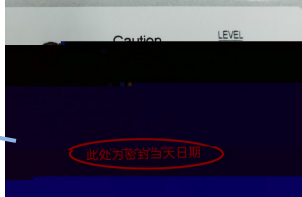



Caution LEVEL
 此处为密封当天日期

/ -					
	图示 /	图示 /	图示 /		

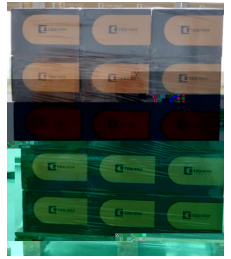
/ :				
	/	/		

--	--	--	--	--

	2 2 . .		
	/		/
	/		/

12. /

①

②