



一级代理商：

深圳市弗瑞鑫电子有限公司

地址：深圳市宝安区西乡大道302号金源商务大厦B座三楼

frxelec



Feature

Decision

3. Application Range

4. Function. 4

5. Abol e Ma im m Ra ing (Ta=25)

Pa ame e		S mbol	Ra ed Val e	Uni



6. Electrical Optical Characteristics at $T_a=25\text{ C}$

Parameter	Symbol	Min	T.*	Max	Unit	Condition
-----------	--------	-----	-----	-----	------	-----------



7. O de Info ma ion

Pa N mbe

OR-M302X-W-Y-Z

o OR-M305X-W-Y-Z

No e

O ion	De c i ion	Packing an i

8. Naming Rule

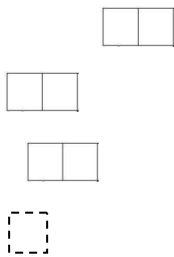
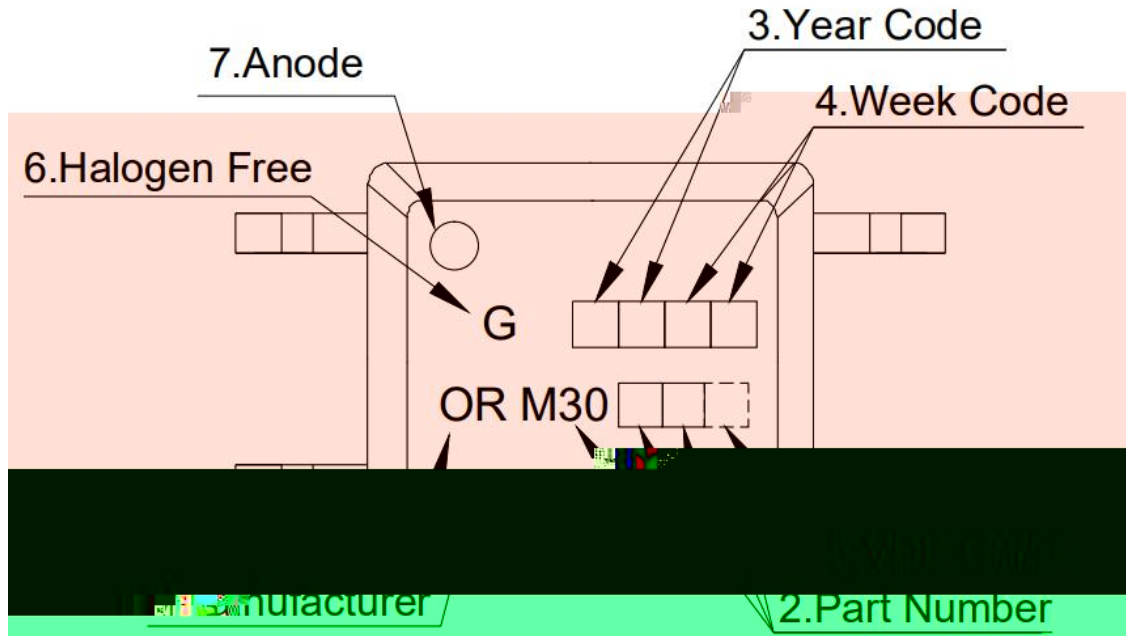

9. Package Dimension

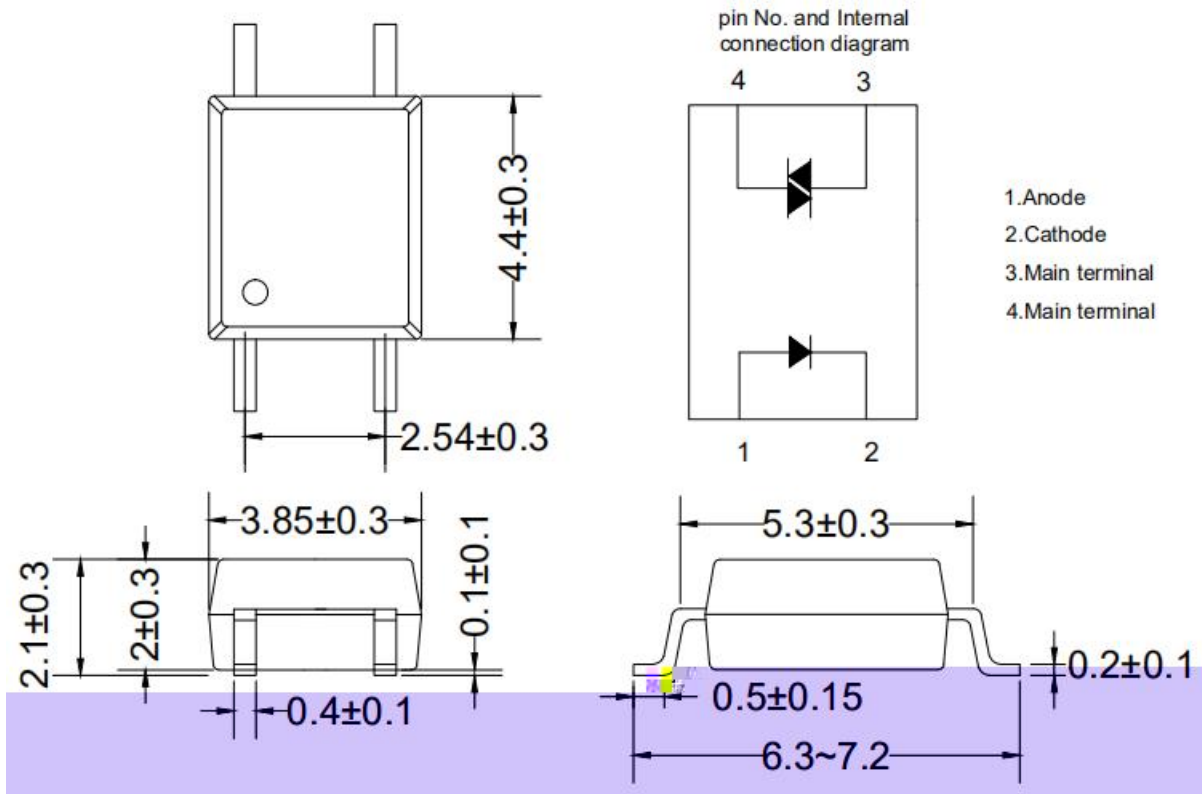

10. Recommended Foot Print Pattern (Mo n Pad)

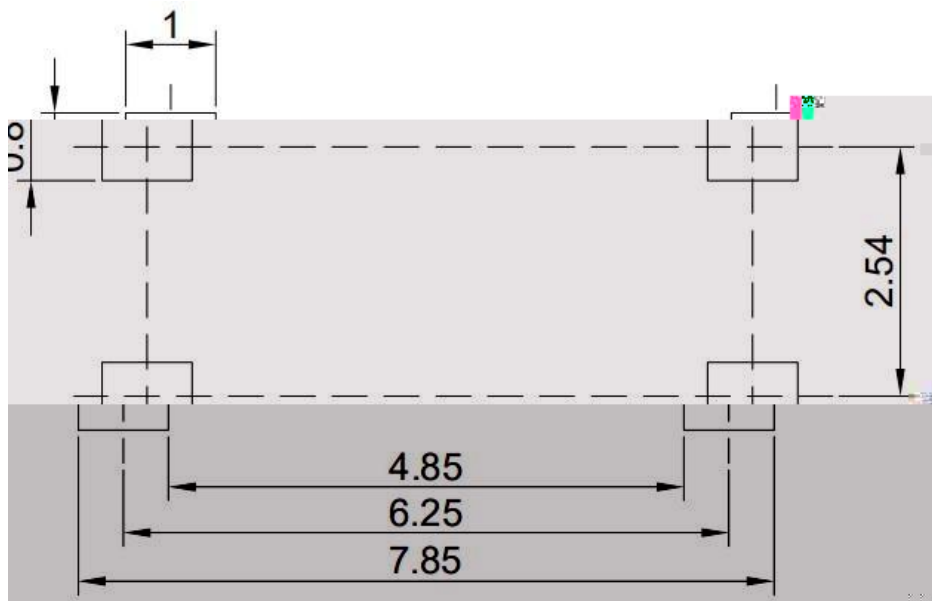

ni mm

11. Ta ing Dimen ion

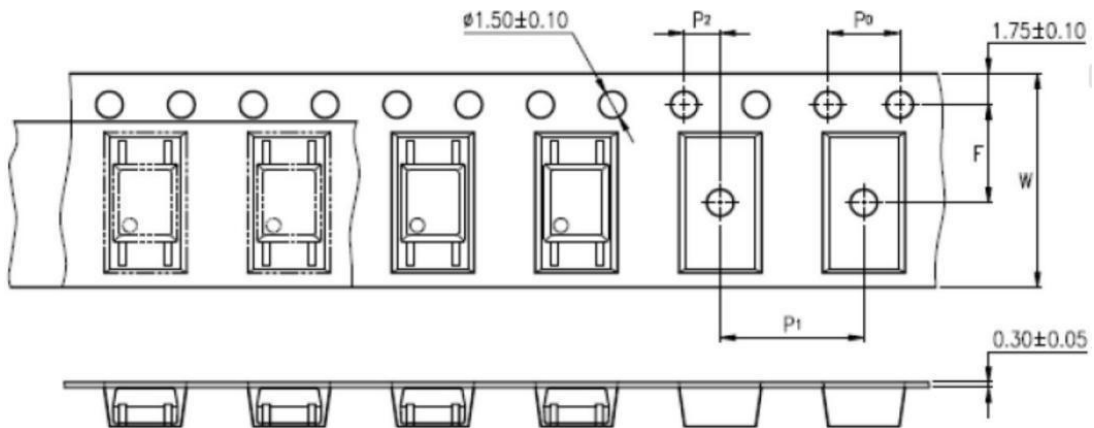
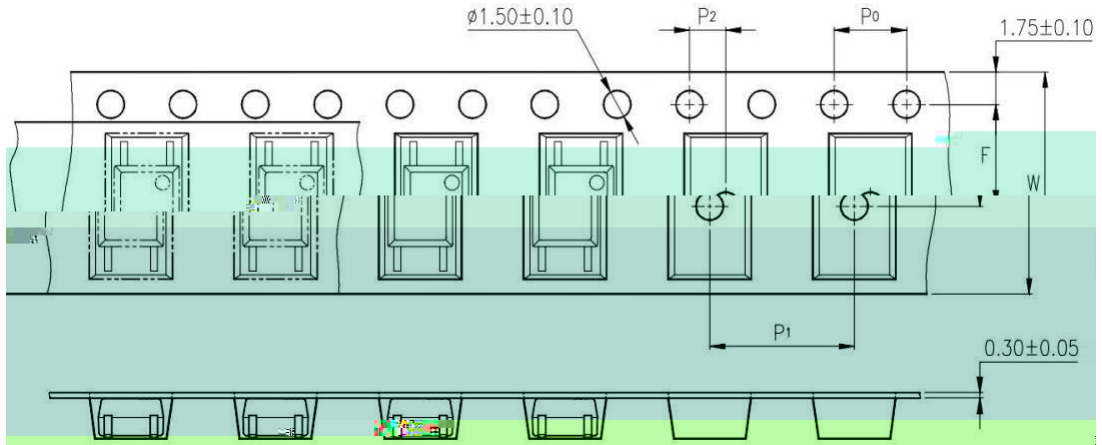









12. Package Dimension

Packing Information	



ORIENT
Shenzhen Orient
Components Co., LTD

Material Code : 120PCXXXXX

 P/N: OR-XXXXXX

 Lot No. : XXXXXX-XXXXX-TX-X

 D/C: XXXX

 Qty: XXXX PCS

内箱码

外箱码

“XXXXXXXXXXXXXXXX” (一体机序列码)
Made in China

No e

13. Temperature Profile Of Soldering

Profile Item	Condition

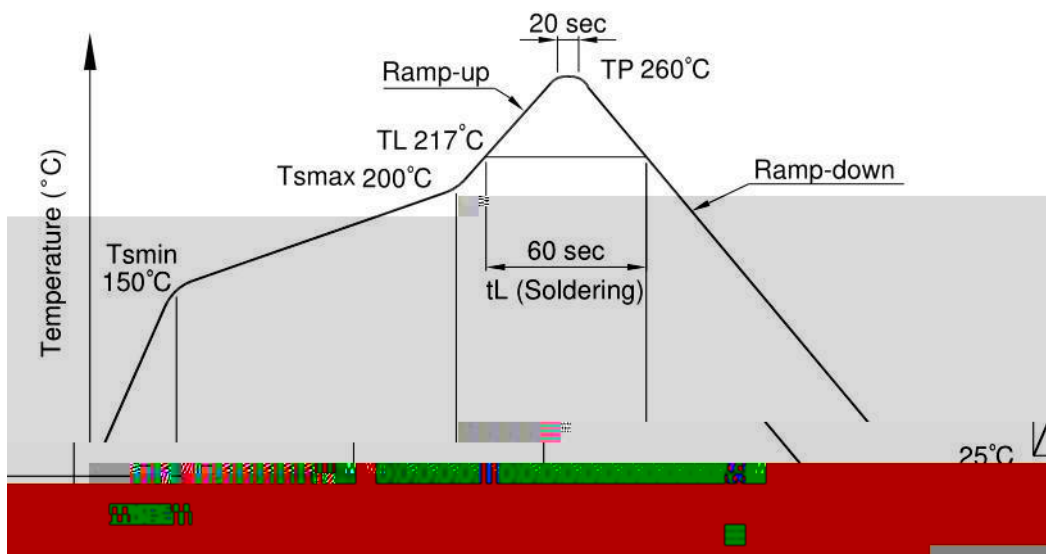

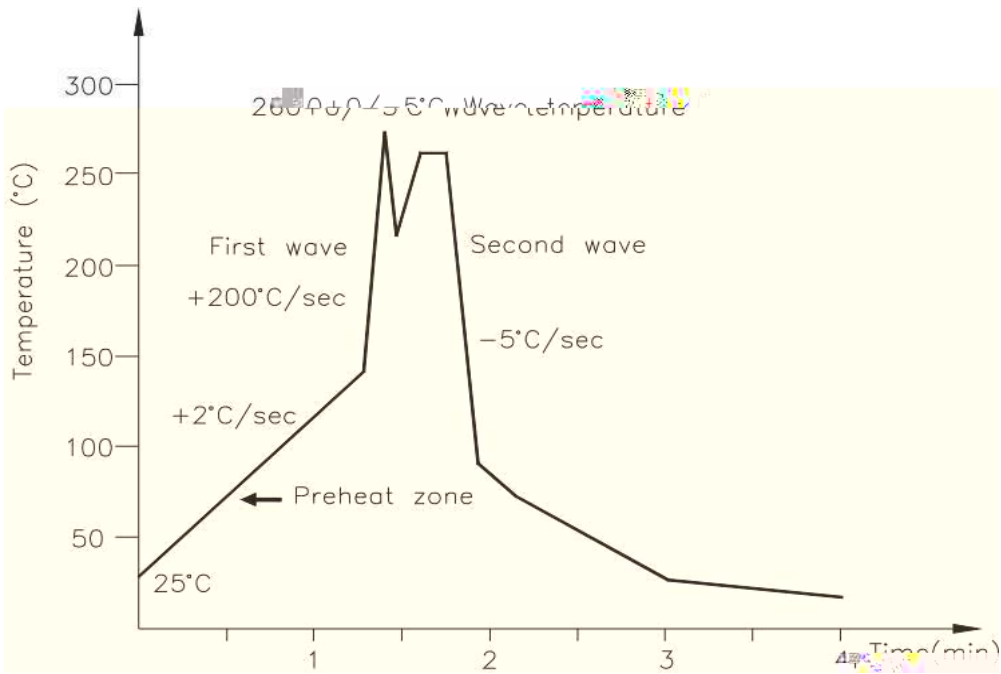

--	--

14. CHARACTERISTICS CURVES (TYPICAL PERFORMANCE)

Fig.1 Forward current vs Ambient temperature

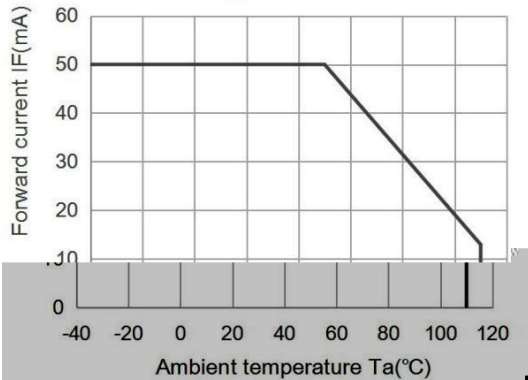

Fig.2 On-state current vs. Ambient temperature

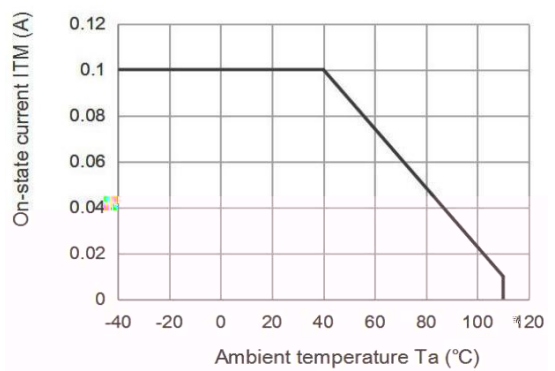

Fig.3 Minimum Trigger Current vs. Ambient temperature

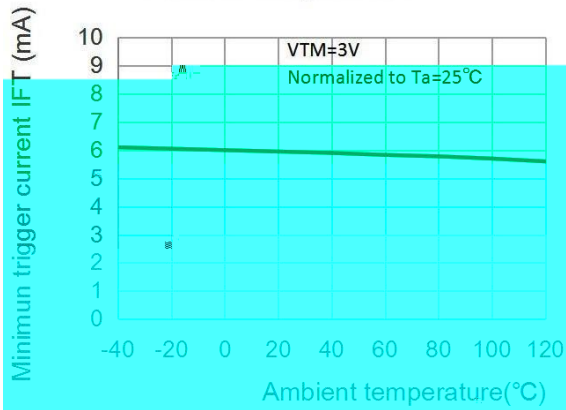

Fig.4 Forward current vs. Forward voltage

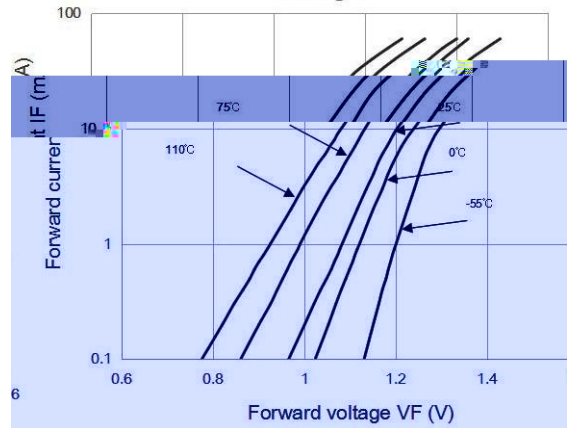

Fig.5 On-state voltage vs. Ambient temperature

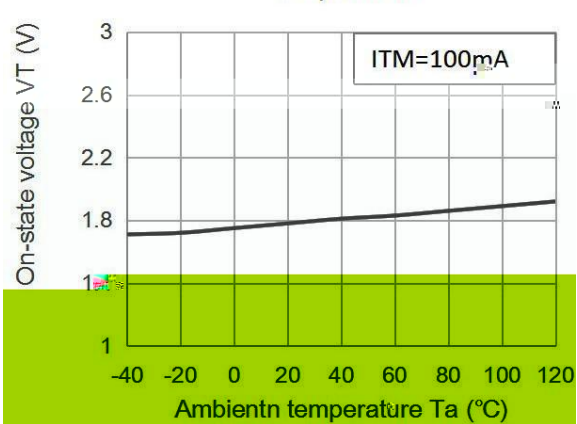

Fig.6 Holding current vs. Ambient temperature

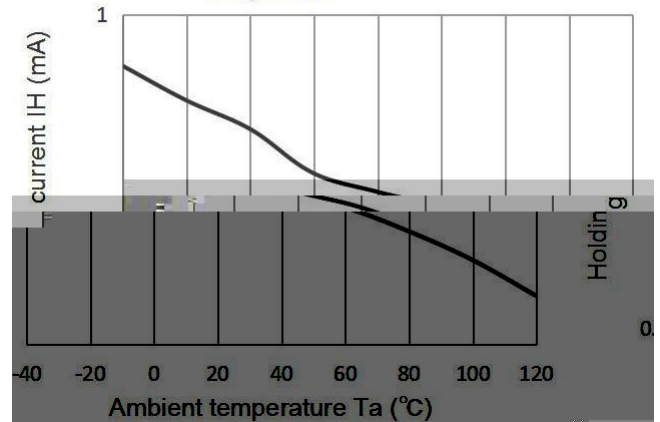

Fig.7 Repetitive peak off-state current

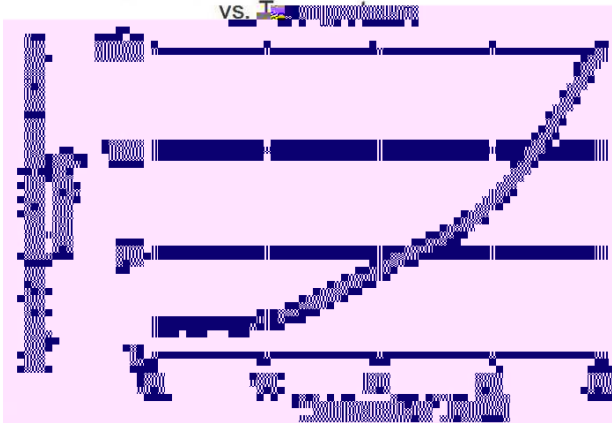
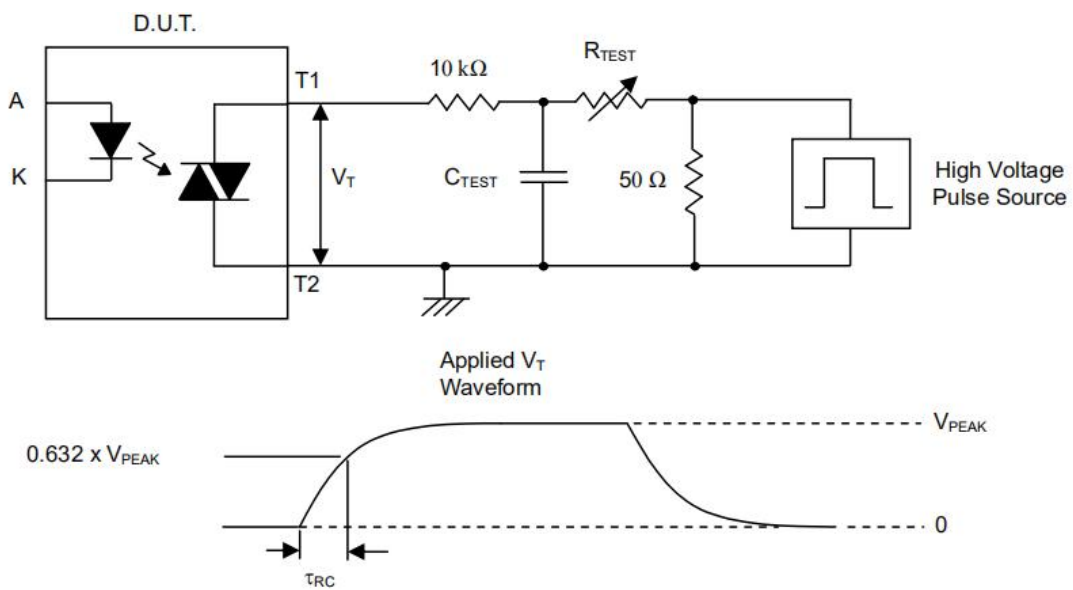
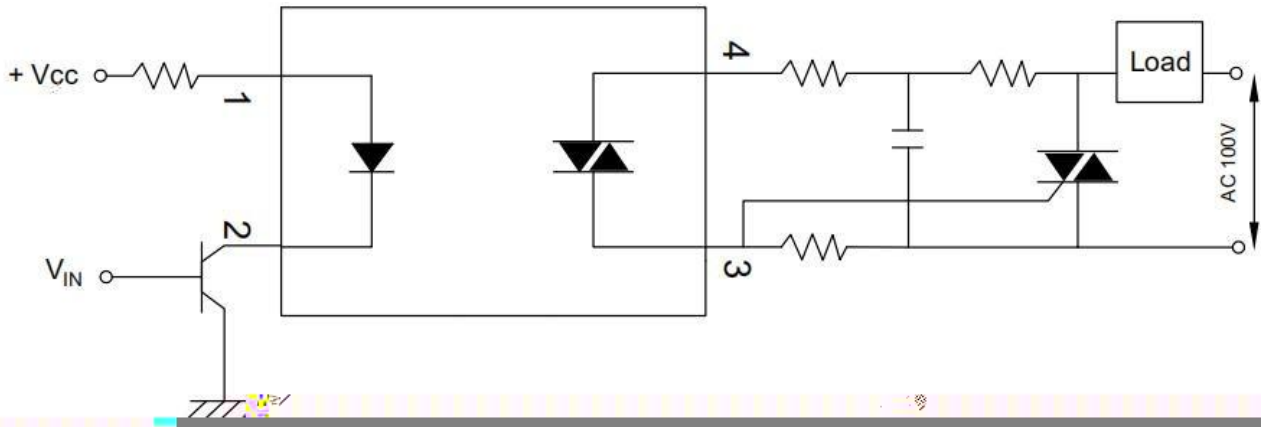
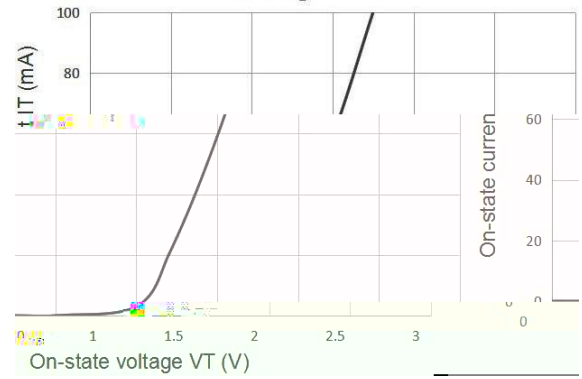

Fig.8 On-state current vs. On-state voltage



Measurement Method

The high voltage pulse is set to the required V_{PEAK} value and applied to the D.U. r. output stage through the RC circuit above. I ED current is not applied. The waveform V_T is monitored using a x100 scope probe. By varying R_T

