

深圳市弗瑞鑫电子有限公司

规格承认书

—

| | | | |
|--|--|--|--|
| | | | |
| | | | |

| | |
|---------|--|
| prepare | |
| | |
| check | |
| | |
| approve | |
| | |



TRX电容一级代理商

深圳市弗瑞鑫电子有限公司

Add: 深圳市宝安区西乡大道302号金源商务大厦B座3楼

Tel: 0755-29563634

Fax: 0755-27447020

- 2

2 . .

/

/

/

/



| | | | |
|--------------|--|---|--|
| - 2 2 . . | | | |
| / | | / | |
| / | | / | |

| | | | |
|---|--------------|--|---|
|  | - 2 2 . . | | |
| | / | | / |
| | / | | / |

1. /

$\overline{\text{①}}$ $\overline{\text{②}}$ $\overline{\text{③}}$ $\overline{\text{④}}$ $\overline{\text{⑤}}$ $\overline{\text{⑥}}$

①

| | | | |
|---|--------------|--|---|
|  | - 2 2 . . | | |
| | / | | / |
| | / | | / |

3. /



4. /

| | | | |
|--|--|--|--|
| | | | |
| | | | |
| | | | |
| | | | |
| | | | |

5. /

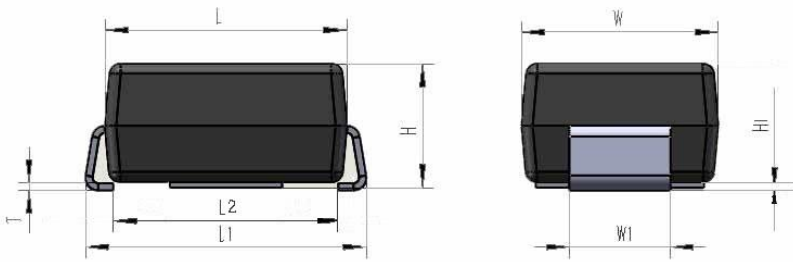

| | | | |
|--|--|--|--|
| | | | |
| | | | |
| | | | |
| | | | |

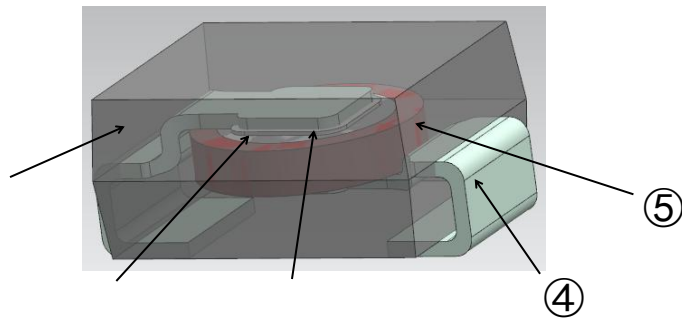

| | | |
|---|--|--|
| | | |
| ① | | |
| ② | | |
| ③ | | |
| ④ | | |
| ⑤ | | |

- 2
2 ..

/

/

/

| | | | |
|---|--------------|--|---|
|  | - 2 2 . . | | |
| | / | | / |
| | / | | / |

/

°
°C

°

°

°

/

7. /

| | | | |
|--|--|--|--|
| | | | |
| | | | |
| | | | |

| | | | |
|---|--------------|--|---|
|  | - 2 2 . . | | |
| | / | | / |
| | / | | / |





- 2
2 ..

/

/

/

/

| | | | | | ± |
|--|--|---|--|--|---|
| | | | | | |
| | | ± | | | |
| | | ± | | | |
| | | ± | | | |
| | | | | | |
| | | | | | |
| | | | | | |
| | | ± | | | |
| | | | | | |
| | | | | | |

| | | | ± ± |
|--|--|--|-------|
| | | | ± ± ± |
| | | | ± ± ± |

8. /

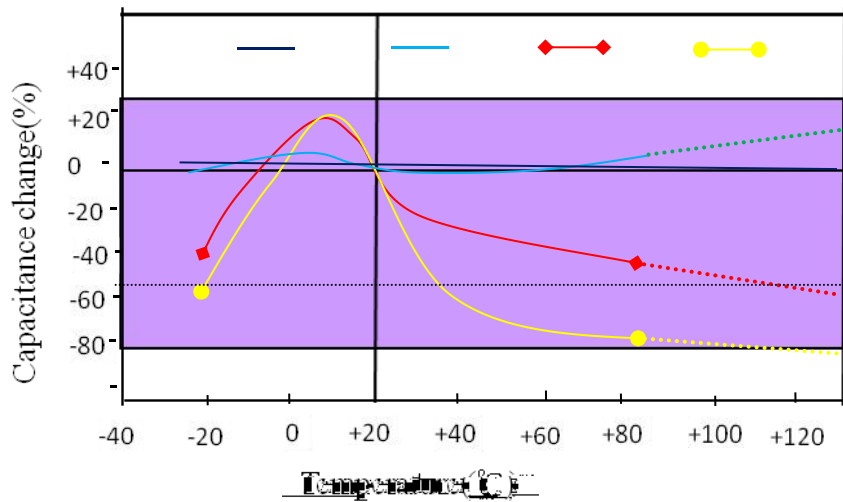

11. /
/

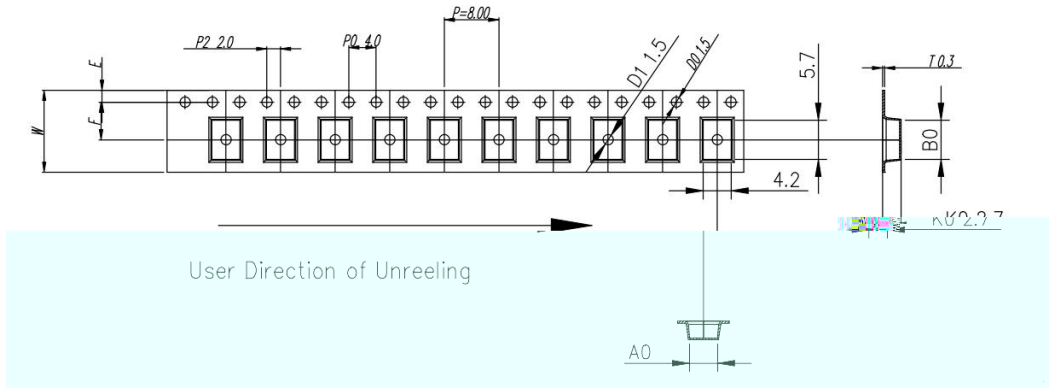

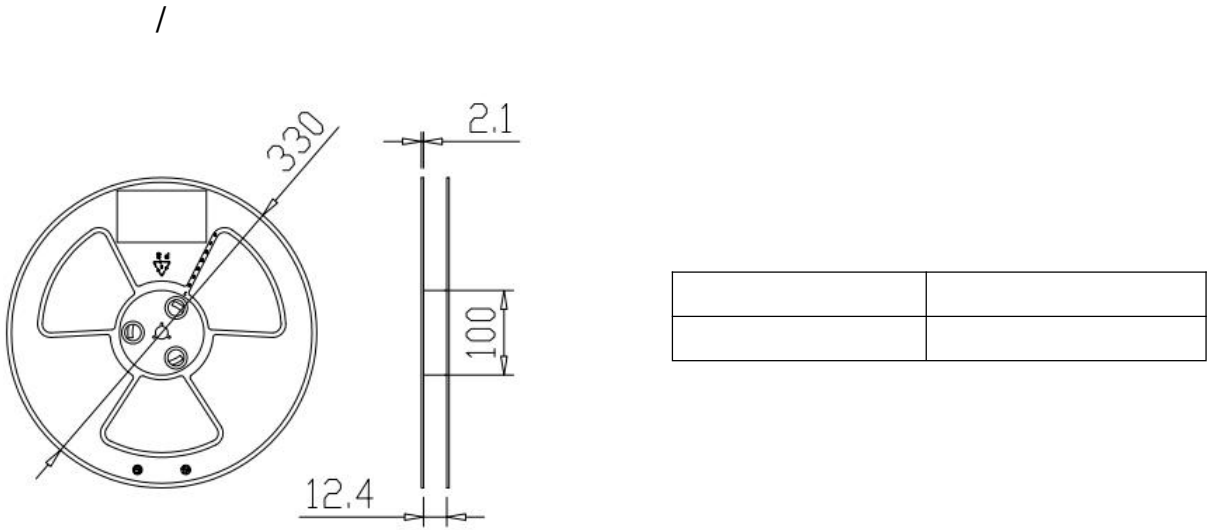

| ITEM | W | A0 | B0 | K1 | K0 | P | F | E | D0 | D1 | P0 | P2 | T |
|-----------|------|----------------------|----------------------|----|----------------------|------|----------------------|------|--------------------------|--------------------------|-----|-----|------|
| DIM | 12.0 | $4.38^{+0.30/-0.30}$ | $5.70^{+0.10/-0.10}$ | -- | $2.70^{+0.10/-0.10}$ | 8.00 | $5.50^{+0.10/-0.10}$ | 1.75 | $\phi 1.5^{+0.10/-0.10}$ | $\phi 1.5^{+0.10/-0.10}$ | 4.0 | 2.0 | 0.30 |
| ALTERNATE | | | | | | | | | | | | | |

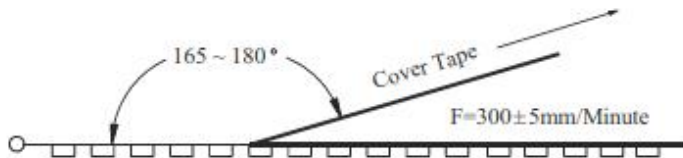

| Item | Data | Remark |
|---------------------|-----------|---|
| Cover tape adhesion | 10 ~ 100g | Carrier tape and cover tape open angle 165 ~ 180° F=300±5mm/minute |

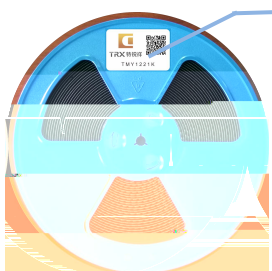

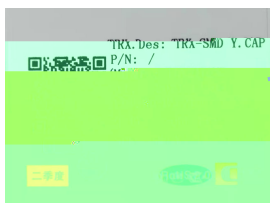
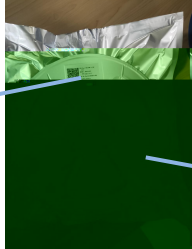
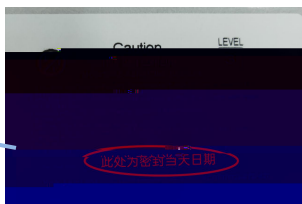
| | | |
|-----|--|--|
| / - | <div style="display: flex; justify-content: space-around;"> <div style="text-align: center;">  <p>标签</p> </div> <div style="text-align: center;">  <p>料号</p> </div> </div> <div style="display: flex; justify-content: space-around; margin-top: 20px;"> <div style="text-align: center;">  </div> <div style="text-align: center;">  </div> <div style="text-align: center;">  <p>此处为贴封当天日期</p> </div> </div> | |
|-----|--|--|

| | | | | | |
|-----|---|--|--|--|--|
| / - | <div style="display: flex; align-items: center;"> <div style="flex: 1;">  </div> <div style="flex: 1;">  <p>图示 /</p> </div> <div style="flex: 1;">  <p>图示 /</p> </div> <div style="flex: 1;">  <p>图示 /</p> </div> </div> <table border="1" style="width: 100%; height: 60px; margin-top: 10px;"> <tr> <td style="width: 25%;"></td> <td style="width: 25%;"></td> <td style="width: 25%;"></td> <td style="width: 25%;"></td> </tr> </table> | | | | |
| | | | | | |

| | |
|-----|---|
| / : | <div style="display: flex; justify-content: space-around;"> <div style="text-align: center;">  <p>/</p> </div> <div style="text-align: center;">  <p>/</p> </div> <div style="text-align: center;">  </div> <div style="text-align: center;">  </div> </div> |
|-----|---|

" "

| | | | |
|---|--------------|--|---|
|  | - 2 2 . . | | |
| | / | | / |
| | / | | / |

12. /

①

②