

	P			
	P X	X	XgX	f
	0		x	
	9		GX	GX f

g X fe f Xgg f X

:L F < _____

:L F < G _____

0 G _____

F < F _____ P

	f	<8:	X f e

g gX	f f fe e
Xgg f	e g fe g X X f fe fgp



TRX 特锐祥

: L8 < L 0 8 > <: F F>P < 8 F 8 :F

< Q < < L 0 8 > < <: F : :F

www.trxc.net

Add sc 1
 Add sz 91 503
 Tel +86-816-61670387/+86-755-27892117
 Fax +86-816-6167076/+86-755-27893019

	P		
	P X	X	XgX f
	0		x
	9	GX	GX f

< :

X X eX	P	0 G	
f F	P	X X e	X

	X	< fe	X fe	X
		M ⁿ fe	X ^f fe e	

f p			Xgg f	
-----	--	--	-------	--



TRX 特信洋
www.trxc.net

: L8 < L 0 8 > <: F F>P < 8 F 8 :F

< Q < < L 0 8 > < <: F : :F

Add sc 1
Add sz 91 503
Tel +86-816-61670387/+86-755-27892117
Fax +86-816-6167076/+86-755-27893019



P			
P X	X	XgX	f
0		x	
9		GX	GX f

fn f f

Y1 F 222 M 064 X 280 A
 Class Dielectric Capacitance Tolerance Dielectric diameter Leads spacing Leads length Lead Type

pg P
 g X f e f X X P G P L P M
 f eX XgX p

P G : XgX p e G=											
: F <											
f eX XgX p											
P L : XgX p e G=											
: F <											
f eX XgX p											
P M : XgX p e G=											
: F <											
f eX XgX p											

: XgX p f X fnX f

G f	P G	P L	P M

	P		f	
	P X	X	XgX	x
	0			
	9		GX	GX f

X

P G											
P L											
P M											

G

P P = ϕ P P x
 = fe

G e Xg

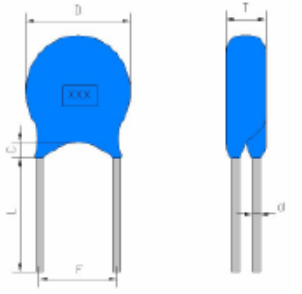
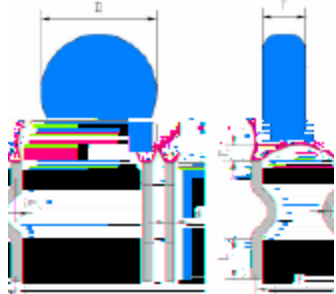
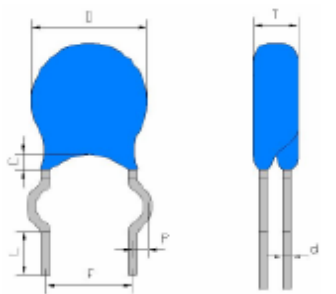
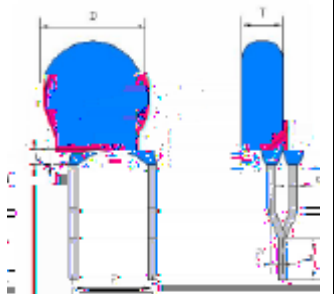
			
8	9	:	

MX f f e fe X f f f gXep Xe X Xgg X fe

f f XeX

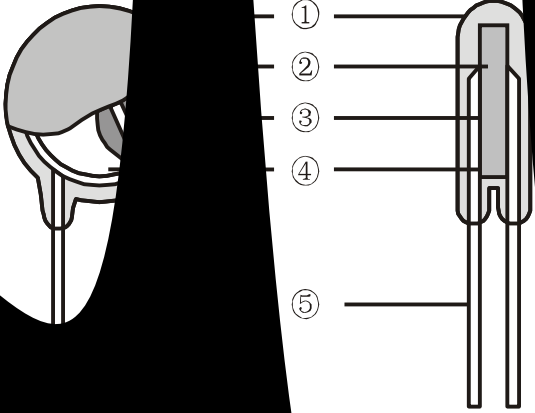

X e

Y110K5

<og X e

X	Xe	
f	e	P
f		9 P G < P L = P M
f X	X	P
f eX XgX	p	
:XgX p f f Xe		
X p X fe X	L	
	:H:	
	< <:	
	M <	
	:	
: M < < <:	M M M8:	
f X f : M < < <:		
L :H:	M	
f X f L :H:		
f f X e		

	P			
	P X	X	XgX	f
	0		x	
	9	GX	GX	f

G f Xe

F		_____
---	--	-------

	P			
	P X	X	XgX	f
	0		x	
	9		GX	GX f

:fe e

F		G f Xe	
---	--	--------	--

P			
P X	X	XgX	f
	0		x
	9	GX	GX f

: fe e

F		G f Xe	X e f
Xg Xe f g X		X oX eX fe	f X X
		f X g ff	X f
		:XgX Xe	P G P L P M
		gX fe X f	P G ∅ P L ∅ P M ∅
		e X fe Xe	X f
M X fe		:XgX f X ef X X	= h e p Xe n e f X X fe X f X fe f ogf X 0 P Q f 0 P Q
X g X X p X		X oX eX f	f X X
		:XgX Xe	: o : :
		f X g ff	X f
		e X fe Xe	o
			g X ≥ p X fe " f f X M8: L f fe X f X g L M XgX f X g X X ≥ f f f X e ≥

P			
P X	X	XgX	f
	0	x	
	9	GX	GX f

:fe e

F	G f Xe	X e f
g f X	f g Xe e X fne f X f e g f	
	Xep g X fne p f f fg fe f f X X XnX f e X e X ef X e X fn e f X f X X e g X e XgX f e ef g X Xgg Xe XgX f X f e X fe f e	G X g f X M g Xe fe
	X g X e Xgg f XgX f Xe f f f X f X nX f e X e X ef X e X fne f X f X f e XgX f X f e X fe f e	
	Xe g X f h X f e XgX f X f e X X efe fe f e	
		x
		x

: fe e

F		G f Xe	X e f															
	<e Xe	<p>X oX eX f e</p> <p>:XgX Xe</p> <p>f X g ff</p> <p>X f</p> <p>e X fe Xe</p>	<p>g X ></p> <p>X fe " f</p> <p>f X</p> <p>M8: L o g X fe p</p> <p>f f X X e X f</p> <p>f</p> <p>M8: L</p> <p>M x</p> <p><X f f X X Xgg</p> <p>f X XgX f e X p f</p> <p>X f f</p> <p>:XgX f X g X X > f</p> <p>f f X e</p> <p>></p>															
	: X Xe X	<p>:XgX Xe</p> <p>:o: :</p> <p>e X fe Xe</p> <p>o</p>	<p>: X f X M8: L</p> <p>e f p</p> <p>X f Xgg fo X p</p> <p>fe fg X fe g fe</p> <p><X p X fe f X e Xe</p> <p>X e XgX f</p> <p><X XgX f X e X p</p> <p>X p Xgg p e f X</p> <p>f X f n X</p> <p>$R = \frac{220 \cdot 10^{-6}}{C_R} \Omega$</p> <p>:XgX f X g X X > f</p> <p>f f X e</p> <p>></p>															
GX X X p		<p>X f p 9</p> <p>e e f Xep</p> <p>g e X ef o</p> <p>g</p> <p>9 e e fg f fn e</p> <p>gX X e fne X ef</p> <p>e gXg</p> <p>x</p>	<p>X f p 9</p> <table border="1"> <tr> <td data-bbox="900 1738 1129 1879">f Xe</td> <td data-bbox="1129 1738 1238 1879">X</td> <td data-bbox="1238 1738 1519 1879">Xo e e</td> </tr> <tr> <td data-bbox="900 1879 1129 1917">M</td> <td data-bbox="1129 1879 1238 1917"></td> <td data-bbox="1238 1879 1519 1917">f</td> </tr> <tr> <td data-bbox="900 1917 1129 1955">M f</td> <td data-bbox="1129 1917 1238 1955"></td> <td data-bbox="1238 1917 1519 1955">f</td> </tr> <tr> <td data-bbox="900 1955 1129 1993">M f</td> <td data-bbox="1129 1955 1238 1993"></td> <td data-bbox="1238 1955 1519 1993">f</td> </tr> <tr> <td data-bbox="900 1993 1129 2150">M</td> <td data-bbox="1129 1993 1238 2150"></td> <td data-bbox="1238 1993 1519 2150">f</td> </tr> </table>	f Xe	X	Xo e e	M		f	M f		f	M f		f	M		f
f Xe	X	Xo e e																
M		f																
M f		f																
M f		f																
M		f																

	P			
	P X	X	XgX	f
	0		x	
	9		GX	GX f

:fe e

F		G f Xe	X e f
	:f gfe e f e Xe	f X X G f Xe X f	f e f fg fgp X f f Xe o feX f gf e f e g X XgX f X f e f fe x f p f
	f e Xe f X e	X e X	f e f fg fgp X f f Xe o feX f gf e f e g X XgX f X f e f fe Xe X X n g n g f

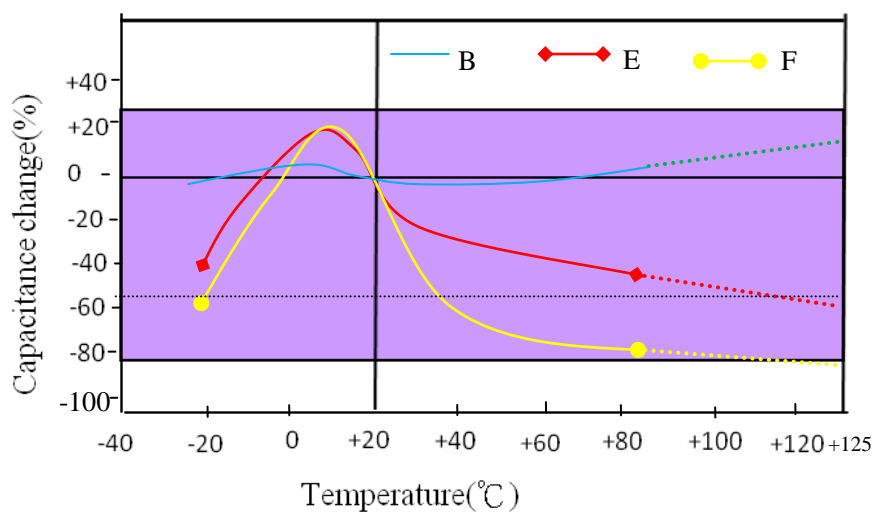



	P			
	P X	X	XgX	f
	0		x	
	9		GX	GX f

: X X f p
8 f e f < 8 8 8



:X f p g X fn Lgg X f p g X X p X X g X
e Xp

< e <

< e X e g X f fg X fe :f

e < Xo X e g X f fg X fe p X

< f Xp X g X X p X





:X f p < oX g X f e f <: <:

=	
nf	ef e e X e
g X	f fg X fe :f
	>
	>
	>
	>
	>
	>
	" >

fe	
X e g X	ef e Xo
X	f fg X fe p
	" >
	" >
	" >
	" >
	" >
	" >
	" >

nf	
X	ef e e f Xp X g
Xp	Xp X
	Xp
	Xp
	Xp
	f gfe e ef
h	f ogf f
	X g X

	P P X X XgX f		
	0	x	
	9	GX	GX f

F	:FL P	8 8 F	: 8 PG< N M : : G = :	= < F	8
	>< 8 P <L FG<	M <	< M < < <:	P P 8: M :	 
	L 8 : 8	L :L	L : 8 <	P P 8: M 9 <	
	: 8	:H:	<:	P P 8: M 9 :H:	
	F <8	:	: :	P P 8: M 9 L 8	

h e f fe e X fe f X e X X f Xe

f <L

X f e

<8: f



Xe	fe e X fe e gg
:X Xe X f gf e	
X Xe X f gf e	
p Xe p f gf e	
oX X e f f gf e	
Gf f eX g ep G99	
Gf f eX g ep G9 <	
: "G " " : " gX e X X " " "	
:	
9	
: "9 "	
M : <8:	

P			
P X	X	XgX	f
0		x	
9		GX	GX f

Xe X e X f 0

f f p X				f f fe		f f Xp			
p X	f	p X	f	fe	f	Xp	f	Xp	f
↓	↓								
	8		G						
	9								
	:								
	<		L						
	=		M						
			N						
	A		O						
		↓	↓						

f p X f g X fe p p X f X fe n g f
x

f X fe fe

XgX f X ef f e X f f X f g n g f
f X X X X f X X g e <ogf f f gfe e f f
f X f

x

: XgX f Xe f f f g f X Xep g X n e e
Xe f X f p g X

x

=f fe f X g f fn f fn e fe fe f f

f X g X f " ≥
f " ≥

Xo X p ef n X fn fe XgX f

Xo X fe fe

P			
P X	X	XgX	f
	0		x
	9	GX	GX f

GX e

8

< F	X e	9X
	f	G:
		G:
	G:	

9 8G< G: 9F0
: XgX f fe Xg pg g

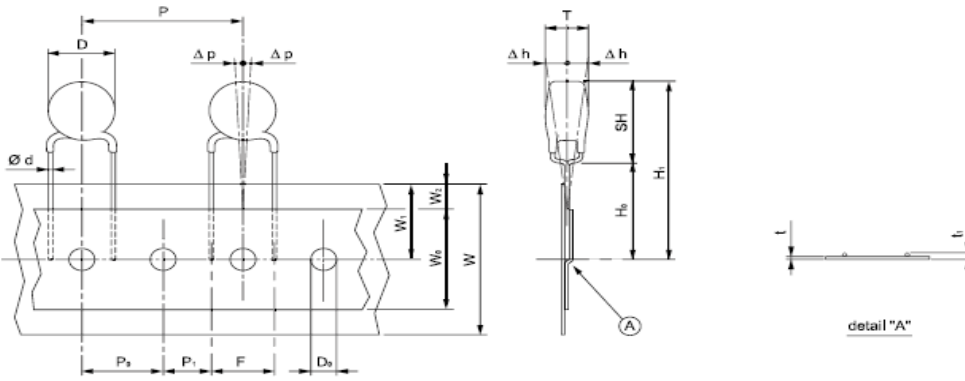

GX X	p f	Xg e g X fe		
		G	G	f Xe
X X				
g n e XgX f	g			
f g	G			
f e f X e	G			
X gX e	=			
f gfe e X e e				
X fe X fe Xg f	g			
Xg n	n			
f fne Xg n	N			
f gf fe	N			
f fne Xg gf fe	N			
X f Xg e				
Xo f gfe e				
f X				
f X Xg e				
Xo e f Xg Xe n				

	P		
	P X	X	XgX f
	0		x
	9	GX	GX f

:X fe Xe nX e e

8 e fe Xne f X X g fe f f X g ff p Xp X X
XgX f

f ef g X XgX f X G: fX n f f gX f g X gX
G: 9 G: 9 G: 9

8 f Xep f g e f o X x
G X fe pf n f XgX f e g X e

f ef f XgX f X X e f f fX
G: 9 x

f ef g g G: fX p f XgX f x

Mf X g ff

8 :f f



Fg X og X e

g f X e Xe e f X e e
x

nf g e f XgX f X e gg e o f f X e e

> X fe X g Xe XgX f Xe Xe f X e e
fg f g n e X

9 < f f x



Fg X og X e

:XgX f nX n f X g f f f f nf g e f XgX f
x



P			
P X	X	XgX	f
	0	x	
	9	GX	GX f

e X efn f X : XgX f

f XgX Xe Xe gX fe X f Xe
 XgX f X X g n ff Xe X XgX f
 ef efe f n Xe : XgX Xe Xe gX fe X f X ef oX X
 f g X e Xe Xe ef
 x

x

XgX f XgX Xe Xe gX fe X f X f X Xp ef
 f XgX f f f f X f X XgX f
 X n e X f f f X f Xe X Xe
 XggX X

x

f Mf X g ff
 : X f XgX f X 8: f : Mf X X Xe e X e
 XggX X X g e XgX f X n X g f XggX X f g gX n e
 X g f XggX X f g Xe X f X f n Xgg e
 n e nf X gX ff X : XgX f fe X fe nX fp
 X e n Xgg e e XgX f f f e

x



P
P X X XgX f

0

x

9

GX

GX

f

f X

e

<: = o XgX f f e fe h g e GX > e g X fe

<: = o XgX f f e fe h g e GX feX

g X fe = o XgX f f f X e e e gg fe Xe fee fe f
gg p X e

>9 <: = X X e f fe g f GX

f fe X

>9 <: = o XgX f f e fe h g e

GX > e g X fe

>9 F X g e g f f e g fe p X
GX X g e e o p X g Xe h X p 8H f f f e g fe
8H

>9 <: G e f f Xe XgX f

>9 <: X e f f f Xe XgX f

A h e f fe e X fe f X e X X f Xe e
fe e f X fe g f

A X e f fe f f gf fe X p fe e f X fe g f

A e f f X X f Xe e fe e f X fe g f

<L f fe f f X e X X f Xe e < X
Xe < fe <h g e

<: N<<< NX < X Xe < fe <h g e

<: < fg GX X e Xe :f e <: f fe
GX X e Xe gX X e nX

<:

f <8: X fe < X X fe 8 f X feXe fe f : X

w w